

**GOODWE**



# **User Manual**

**Grid-Tied PV Inverter**

MS Series

5.0-11.4kW G3(US)

V1.8-2025-09-23

**Copyright ©GoodWe Technologies Co., Ltd., 2025. All rights reserved**

No part of this manual can be reproduced or transmitted to the public platform in any form or by any means without the prior written authorization of GoodWe Technologies Co., Ltd.

**Trademarks**

**GOODWE** and other GOODWE trademarks are trademarks of GoodWe Technologies Co.,Ltd. All other trademarks or registered trademarks mentioned in this manual are owned by GoodWe Technologies Co.,Ltd.

**NOTICE**

The information in this user manual is subject to change due to product updates or other reasons. This guide cannot replace the product labels or the safety precautions in the user manual unless otherwise specified. All descriptions here are for guidance only.

# CONTENT

|          |                                      |           |
|----------|--------------------------------------|-----------|
| <b>1</b> | <b>About This Manual</b>             | <b>1</b>  |
| 1.1      | Applicable Model                     | 1         |
| 1.2      | Target Audience                      | 1         |
| 1.3      | Symbol Definition                    | 2         |
| <b>2</b> | <b>IMPORTANT SAFETY INSTRUCTIONS</b> | <b>3</b>  |
| 2.1      | General Safety                       | 3         |
| 2.2      | DC Side                              | 3         |
| 2.3      | AC Side                              | 4         |
| 2.4      | Inverter Installation                | 4         |
| 2.5      | Personal Requirements                | 5         |
| <b>3</b> | <b>Product Introduction</b>          | <b>6</b>  |
| 3.1      | Application Scenarios                | 6         |
| 3.2      | Circuit Diagram                      | 6         |
| 3.3      | Supported Grid Types                 | 7         |
| 3.4      | Inverter Operation Mode              | 8         |
| 3.5      | Functionality                        | 9         |
| 3.6      | Appearance                           | 9         |
| 3.6.1    | Parts                                | 9         |
| 3.6.2    | Dimensions                           | 10        |
| 3.6.3    | Indicators                           | 10        |
| 3.6.4    | Nameplate                            | 11        |
| <b>4</b> | <b>Check and Storage</b>             | <b>12</b> |
| 4.1      | Check Before Receiving               | 12        |
| 4.2      | Deliverables                         | 12        |
| 4.3      | Storage                              | 13        |
| <b>5</b> | <b>Installation</b>                  | <b>14</b> |
| 5.1      | Installation Requirements            | 14        |
| 5.2      | Inverter Installation                | 17        |
| 5.2.1    | Moving the Inverter                  | 17        |

|           |                                                     |           |
|-----------|-----------------------------------------------------|-----------|
| <b>6</b>  | <b>Electrical Connection.....</b>                   | <b>18</b> |
| 6.1       | Safety Precaution.....                              | 18        |
| 6.2       | Preparations before Installation.....               | 19        |
| 6.2.1     | Terminal Introduction.....                          | 19        |
| 6.2.2     | Cable Specification.....                            | 19        |
| 6.3       | Opening the wiring cover.....                       | 21        |
| 6.3       | Connecting the PV Input Cable.....                  | 21        |
| 6.4       | Connecting the AC Output Cable.....                 | 23        |
| 6.5       | Communication.....                                  | 24        |
| 6.5.1     | Communication Network Introduction.....             | 24        |
| 6.5.2     | Connecting the Communication Cable.....             | 25        |
| 6.5.3     | Connecting the antenna(optional).....               | 27        |
| 6.5.4     | Installing the Communication Module (optional)..... | 28        |
| <b>7</b>  | <b>Equipment Commissioning.....</b>                 | <b>29</b> |
| 7.1       | Check Before Power ON.....                          | 29        |
| 7.2       | Power On.....                                       | 29        |
| <b>8</b>  | <b>System Commissioning.....</b>                    | <b>30</b> |
| 8.1       | Indicators and Buttons.....                         | 30        |
| 8.2       | Upgrading the Firmware Via USB Flash Disk.....      | 31        |
| 8.3       | Setting Inverter Parameters via SolarGo App.....    | 31        |
| 8.4       | Monitoring via SEMS Portal.....                     | 31        |
| <b>9</b>  | <b>Maintenance.....</b>                             | <b>32</b> |
| 9.1       | Power Off the Inverter.....                         | 32        |
| 9.2       | Removing the Inverter.....                          | 32        |
| 9.3       | Disposing of the Inverter.....                      | 32        |
| 9.4       | Troubleshooting.....                                | 32        |
| 9.5       | Routine Maintenance.....                            | 40        |
| <b>10</b> | <b>Technical Parameters.....</b>                    | <b>41</b> |
| <b>11</b> | <b>Appendix.....</b>                                | <b>47</b> |
| 11.1      | Precision of inverter parameters.....               | 47        |

# 1 About This Manual

This manual describes the product information, installation, electrical connection, commissioning, troubleshooting, and maintenance. Read through this manual before installing and operating the product. All the installers and users have to be familiar with the product features, functions, and safety precautions. This manual is subject to update without notice. For more product details and latest documents, visit <https://en.goodwe.com>.

## 1.1 Applicable Model

This manual applies to the listed inverters below (MS for short):



| Model          | Nominal Output Power | Nominal Output Voltage |
|----------------|----------------------|------------------------|
| GW5000-MS-US30 | 5000W                | 240V                   |
|                | 4333W                | 208V                   |
| GW6000-MS-US30 | 6000W                | 240V                   |
|                | 5200W                | 208V                   |
| GW7600-MS-US30 | 7600W                | 240V                   |
|                | 6580W                | 208V                   |
| GW7700-MS-US30 | 7680W                | 240V                   |
|                | 6650W                | 208V                   |
| GW9600-MS-US30 | 9600W                | 240V                   |
|                | 8320W                | 208V                   |
| GW11K4-MS-US30 | 11400W               | 240V                   |
|                | 9880W                | 208V                   |

## 1.2 Target Audience

This manual applies to trained and knowledgeable technical professionals. The technical personnel has to be familiar with the product, local standards, and electric systems.

### 1.3 Symbol Definition

Different levels of warning messages in this manual are defined as follows:

|                                                                                                                |
|----------------------------------------------------------------------------------------------------------------|
|  <b>DANGER</b>                |
| Indicates a high-level hazard that, if not avoided, will result in death or serious injury.                    |
|  <b>WARNING</b>               |
| Indicates a medium-level hazard that, if not avoided, could result in death or serious injury.                 |
|  <b>CAUTION</b>               |
| Indicates a low-level hazard that, if not avoided, could result in minor or moderate injury.                   |
| <b>NOTICE</b>                                                                                                  |
| Highlight and supplement the texts. Or some skills and methods to solve product-related problems to save time. |

## 2 IMPORTANT SAFETY INSTRUCTIONS

### SAVE THESE INSTRUCTIONS

Please strictly follow these safety instructions in the user manual during the operation.

#### NOTICE

The inverters are designed and tested strictly complies with related safety rules. Read and follow all the safety instructions and cautions before any operations. Improper operation might cause personal injury or property damage as the inverters are electrical equipment.

### 2.1 General Safety

#### NOTICE

- The information in this user manual is subject to change due to product updates or other reasons. This guide cannot replace the product labels or the safety precautions in the user manual unless otherwise specified. All descriptions here are for guidance only.
- Before installations, read through the quick installation guide. For additional information, please see the user manual.
- All installations should be performed by trained and knowledgeable technicians who are familiar with local standards and safety regulations.
- Use insulating tools and wear personal protective equipment when operating the equipment to ensure personal safety. Wear anti-static gloves, cloths, and wrist strips when touching electron devices to protect the inverter from damage.
- Strictly follow the installation, operation, and configuration instructions in this manual. The manufacturer shall not be liable for equipment damage or personal injury if you do not follow the instructions. For more warranty details, please visit <https://en.goodwe.com/warranty>.

### 2.2 DC Side

#### DANGER

Connect the DC cables using the delivered PV connectors. The manufacturer shall not be liable for the equipment damage if other connectors or terminals are used.

#### WARNING

- Ensure the component frames and the bracket system are securely grounded.
- Ensure the DC cables are connected tightly, securely and correctly.
- Measure the DC cable using the multimeter to avoid reverse polarity connection. Also, the voltage should be under the permissible range.
- Do not connect the same PV to multiple inverters. Otherwise, the inverters may be damaged.

### 2.3 AC Side









**⚠ WARNING**

- The voltage and frequency at the connection point meet the inverter grid connection requirements
- Additional protective devices like circuit breakers or fuses are recommended on the AC side. Specification of the protective device should be at least 1.25 times the rated AC output rated current.
- Make sure that all the groundings are tightly connected. When there are multiple inverters, make sure that all the grounding points on the enclosures are equipotential bonding.
- You are recommended to use copper cables as AC output cables. Contact the manufacturer if you want to use other cables.

### 2.4 Inverter Installation

**⚠ DANGER**

- Do not apply mechanical load to the terminals, otherwise the terminals can be damaged.
- All labels and warning marks should be visible after the installation. Do not scrawl, damage, or cover any label on the device.
- For 240V Delta AC Grid, inverters should not be installed in multiple phase combination.
- Warning labels on the inverter are as follows.

|                                                                                     |                                                                                                                 |                                                                                     |                                                                                                                                                                   |
|-------------------------------------------------------------------------------------|-----------------------------------------------------------------------------------------------------------------|-------------------------------------------------------------------------------------|-------------------------------------------------------------------------------------------------------------------------------------------------------------------|
|    | <p>DANGER High voltage hazard. Disconnect all incoming power and turn off the product before working on it.</p> |    | <p>Delayed discharge. Wait 5 minutes after power off until the components are completely discharged.</p>                                                          |
|   | <p>Read through the user manual before working on this device.</p>                                              |   | <p>Potential risks exist. Wear proper PPE before any operations.</p>                                                                                              |
|  | <p>High-temperature hazard. Do not touch the product under operation to avoid being burnt.</p>                  |  | <p>Grounding point.</p>                                                                                                                                           |
|  | <p>SGS Marking for the United States of America and Canada.</p>                                                 |  | <p>Do not dispose of the inverter as household waste. Discard the product in compliance with local laws and regulations, or send it back to the manufacturer.</p> |
|  | <p>Support Type 1 DC Arc detection on PV side.</p>                                                              | <p style="text-align: center;">-</p>                                                | <p style="text-align: center;">-</p>                                                                                                                              |



## 2.5 Personal Requirements

### NOTICE

- Personnel who install or maintain the equipment must be strictly trained, learn about safety precautions and correct operations.
- Only qualified professionals or trained personnel are allowed to install, operate, maintain, and replace the equipment or parts.

### 3 Product Introduction

#### 3.1 Application Scenarios

The MS inverter is a single-phase PV string grid-tied inverter, which converts the DC power generated by the PV module into AC power for loads or the grid. The intended use of the inverter is as follows:

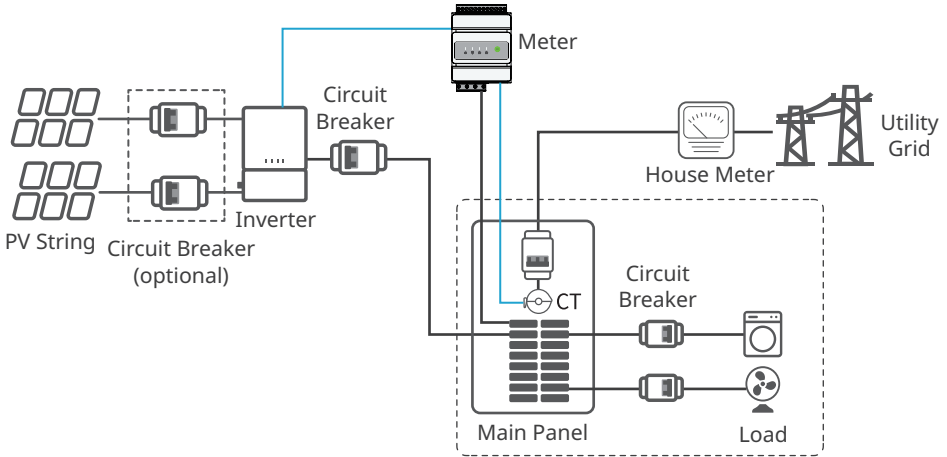

#### 3.2 Circuit Diagram

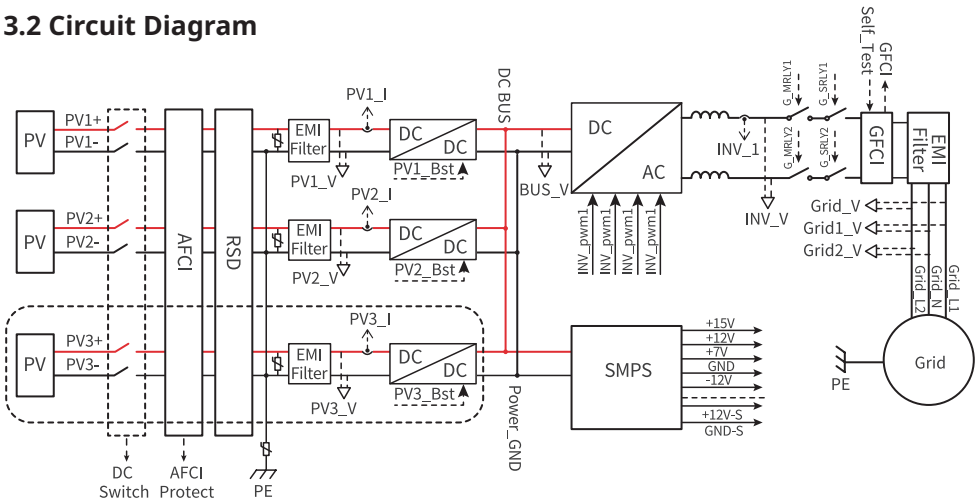

PV3 only for GW7700-MS-US30, GW9600-MS-US30, GW11K4-MS-US30.

### 3.3 Supported Grid Types

The inverter supports 240V/120V Split Phase AC Grid and 208V Delta AC Grid.

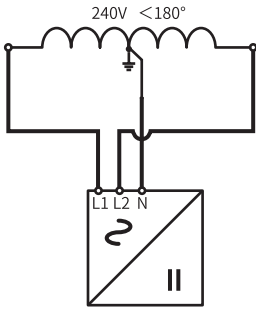

240V/120V Split Phase AC Grid

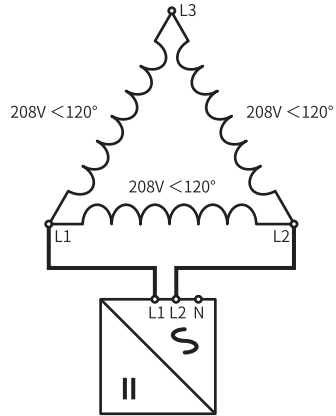

208V Delta AC Grid

### 3.4 Inverter Operation Mode

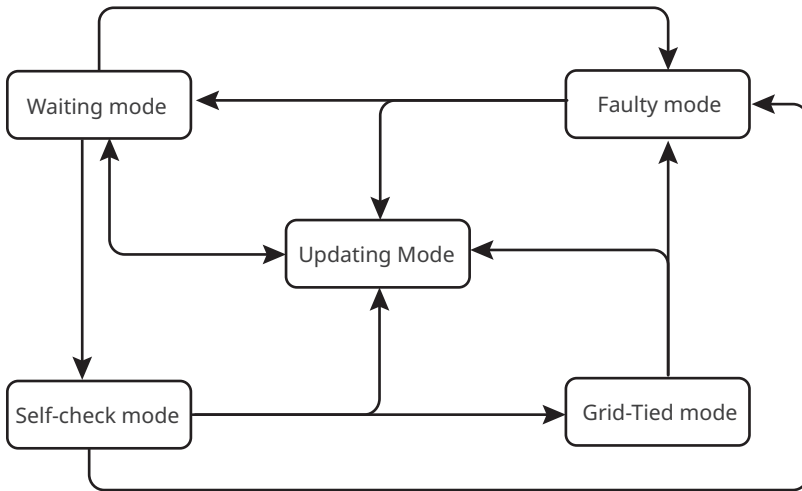

| No. | Parts           | Description                                                                                                                                                                                                                                                                                                                                                                                               |
|-----|-----------------|-----------------------------------------------------------------------------------------------------------------------------------------------------------------------------------------------------------------------------------------------------------------------------------------------------------------------------------------------------------------------------------------------------------|
| 1   | Waiting mode    | Waiting stage after the inverter is powered on. <ul style="list-style-type: none"> <li>When the conditions are met, it enters the self-check mode.</li> <li>If there is a fault, the inverter enters the fault mode.</li> <li>If an updating request is received, the inverter enters the updating mode.</li> </ul>                                                                                       |
| 2   | Self-check mode | Before the inverter starts up, it continuously performs self-check, initialization, etc. <ul style="list-style-type: none"> <li>When the conditions are met, it enters the grid-tied mode, and the inverter starts on grid connection.</li> <li>If an updating request is received, the inverter enters the updating mode.</li> <li>If the self-check is not passed, it enters the fault mode.</li> </ul> |
| 3   | Grid-Tied mode  | The inverter is grid-tied successfully, making energy conversion and controlling the power in PV systems. <ul style="list-style-type: none"> <li>If a fault is detected, it enters the fault mode.</li> <li>If an updating request is received, the inverter enters the updating mode.</li> </ul>                                                                                                         |
| 4   | Faulty mode     | If a fault is detected, the inverter enters the fault mode. When the fault is cleared, it enters the wait mode.                                                                                                                                                                                                                                                                                           |
| 5   | Updating Mode   | When the inverter is upgrading the program, it enters the updating mode. <ul style="list-style-type: none"> <li>When the upgrading is finished, it enters the waiting mode.</li> </ul>                                                                                                                                                                                                                    |

### 3.5 Functionality

#### Ezlink

The inverter has a built-in Ezlink module supporting IEEE2030.5 communication protocol. It supports setting the inverter via Bluetooth in a short distance; connecting to the server via 4G, WiFi or LAN to monitor the inverter and power plant operation, etc.

- Bluetooth: meets Bluetooth 5.1 standard.
- 4G (optional): supports AT&T and T-Mobile mainstream service provider.
- WiFi: supports 2.4G frequency band. Set the router to 2.4G or 2.4G/5G coexistence mode (User can set 40 bytes for router wireless signal name maximumly.)
- LAN (optional): supports connecting to the router via LAN communication and then connecting to the server.

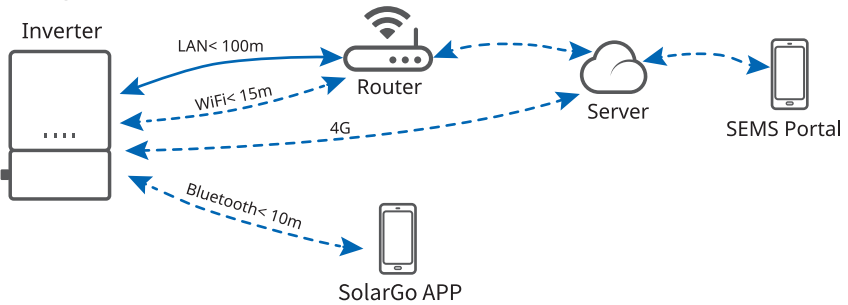

### 3.6 Appearance

#### 3.6.1 Parts

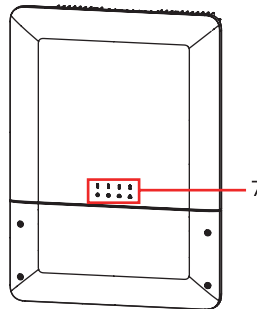
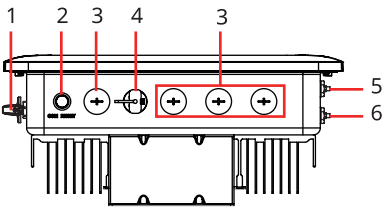

Back view of MS inverter

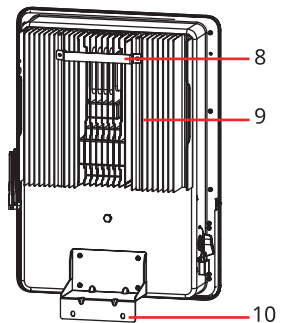

| No. | Parts                    | Description                                      |
|-----|--------------------------|--------------------------------------------------|
| 1   | DC Switch                | Start or stop DC input.                          |
| 2   | Ezlink Reset Button      | Optional, able to reset the Ezlink.              |
| 3   | Cable Hole               | Inverter cable inlet and outlet.                 |
| 4   | COM Module Port          | Optional, able to be connected with WiFi module. |
| 5   | Port for WiFi/BT antenna | Able to be connected with WiFi or BT antenna.    |
| 6   | Port for 4G antenna      | Optional, able to be connected with 4G antenna.  |
| 7   | Indicator                | Indicates working state of the inverter.         |

| No. | Parts                | Description                   |
|-----|----------------------|-------------------------------|
| 8   | Mounting Plate       | Used to install the inverter. |
| 9   | Heat sink            | Used to cool the inverter.    |
| 10  | Inverter fixing part | Used to fix the inverter.     |

### 3.6.2 Dimensions

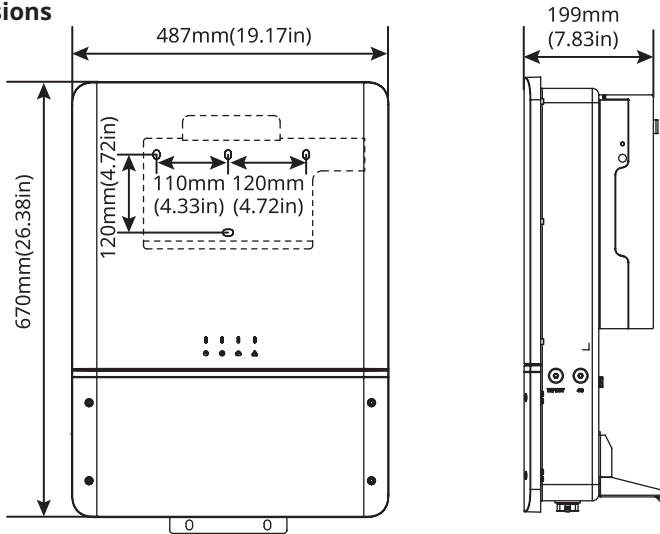



### 3.6.3 Indicators

| Indicator | Status | Description                                                  |
|-----------|--------|--------------------------------------------------------------|
| ⏻         |        | ON = Equipment Power On                                      |
|           |        | OFF = Equipment Power Off                                    |
| ▶         |        | ON = The Inverter Is Feeding Power                           |
|           |        | OFF = The inverter is not feeding power                      |
|           |        | Single slow flash = Self check before connecting to the grid |
|           |        | Single flash = Connecting to the grid                        |
| ☁         |        | ON = Wireless is connected/active                            |
|           |        | Blink 1 = Wireless system is resetting                       |
|           |        | Blink 2 = Wireless router not connected                      |
|           |        | Blink 4 = Wireless server problem                            |
|           |        | Blink = RS485 is connected                                   |
|           |        | OFF = Wireless is not active                                 |
| ⚠         |        | ON = A fault has occurred                                    |
|           |        | OFF = No fault                                               |

### 3.6.4 Nameplate

The nameplate is for reference only.

|                                                                                                                                                                                                                                                       |
|-------------------------------------------------------------------------------------------------------------------------------------------------------------------------------------------------------------------------------------------------------|
| <b>Product: Grid-Tied PV Inverter</b><br><b>Model : ****_**_**</b>                                                                                                                                                                                    |
| Vmax PV: **Vd.c.<br>MPPT voltage range: **... **Vd.c.<br>Max. PV current: **/**Ad.c.<br>Isc PV:**/**Ad.c.                                                                                                                                             |
| Rated grid voltage: **Va.c.<br>Output voltage range: **~**Va.c.<br>AC-grid frequency: **Hz<br>AC-grid frequency range: **~**Hz<br>Max current: **Aa.c.<br>Rated active power: **Va.c.<br>Rated apparent power: **Va.c.<br>Max apparent power: **Va.c. |
| Power factor range: ~*,*cap..*ind<br>Operating temperature range: -**~**°F(**°C~**°C)<br>Derating temperature: **°F(**°C)<br>Grid Support Utility Interactive Inverter Transformerless<br>Type 4X, PV DC AFCI: Type 1<br>Contains FCC ID:*****_**     |
| <br>                                                                                |
| S/N:<br><br>***** Co.,Ltd.<br>*****@***.com<br>*** ** ** ** **<br>S/N                                                                                                                                                                                 |

GW trademark, product type, and product model

Technical parameters

Safety symbols and certification marks

Contact information and serial number

## 4 Check and Storage

### 4.1 Check Before Receiving

Check the following items before receiving the product.

1. Check the outer packing box for damage, such as holes, cracks, deformation, and other signs of equipment damage. Do not unpack the package and contact the supplier as soon as possible if any damage is found.
2. Check the inverter model. If the inverter model is not what you requested, do not unpack the product and contact the supplier.
3. Check the deliverables for correct model, complete contents, and intact appearance. Contact the supplier as soon as possible if any damage is found.

### 4.2 Deliverables

**WARNING**

Connect the DC cables with the delivered terminals. The manufacturer shall not be liable for the damage if other terminals are used.

**NOTICE**

- The antenna is shipped according to the communication mode supported by the inverter.
- The communication module only applicable to models without built-in Ezlink module.

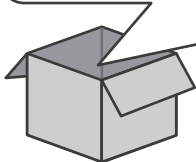
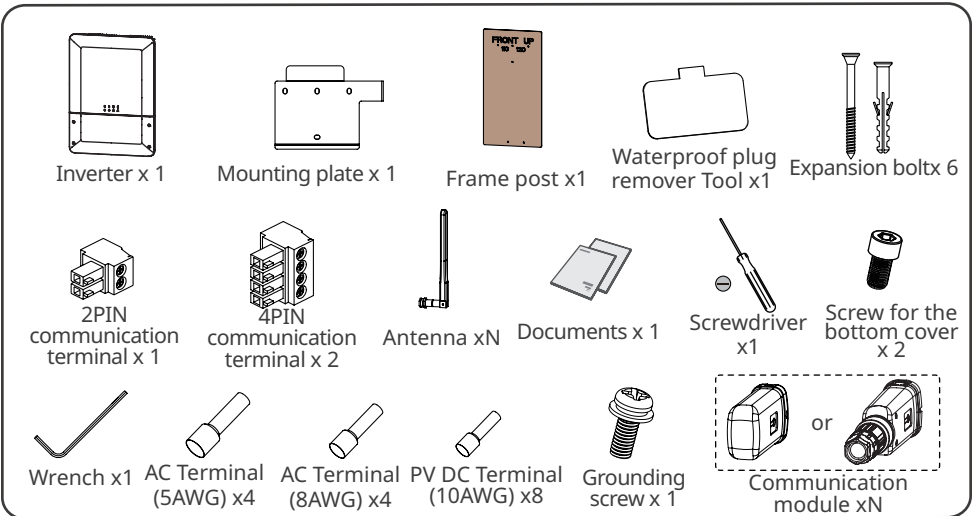



## 4.3 Storage

### NOTICE

The storage time of the inverter should not exceed two years. If the storage time exceeds two years, it must be inspected and tested by professionals before being put into use.

If the equipment is not to be installed or used immediately, please ensure that the storage environment meets the following requirements:

1. Do not unpack the outer package or throw the desiccant away.
2. Store the equipment in a clean place. Make sure the temperature and humidity are appropriate and no condensation.
3. The height and direction of the stacking inverters should follow the instructions on the packing box.
4. The inverters must be stacked with caution to prevent them from falling.
5. If the inverter has been long term stored, it should be checked by professionals before being put into use.

## 5 Installation

### 5.1 Installation Requirements

#### Installation Environment Requirements

1. Do not install the equipment in a place near flammable, explosive, or corrosive materials.
2. Install the equipment on a surface that is solid enough to bear the inverter weight.
3. Install the equipment in a well-ventilated place to ensure good dissipation. Also, the installation space should be large enough for operations.
4. The equipment with a high ingress protection rating can be installed indoors or outdoors. The temperature and humidity at the installation site should be within the appropriate range.
5. Install the equipment in a sheltered place to avoid direct sunlight, rain, and snow. Build a sunshade if it is needed.
6. Install the equipment in a well-ventilated place to ensure good dissipation. Also, the installation space should be large enough for operations.
7. Do not install the equipment in a place that is easy to touch, especially within children's reach. High temperature exists when the equipment is working. Do not touch the surface to avoid burning.
8. Install the equipment at a height that is convenient for operation and maintenance, electrical connections, and checking indicators and labels.
9. The altitude to install the inverter shall be lower than the maximum working altitude 3000m(9842ft).
10. The inverter is easy to be corroded when installed in salt areas. Please consult the inverter manufacturer before installing it outdoors in salt areas. A salt area refers to the region within 1000m(3281ft) offshore or affected by the sea breeze. The area prone to the sea breeze varies depending on weather conditions (e.g. typhoon, monsoon) or terrain (such as dams and hills).
11. Install the inverter away from high magnetic field to avoid electromagnetic interference. If there is any radio or wireless communication equipment below 30MHz near the inverter, you have to:
  - Install the inverter at least 30m(98.43ft) far away from the wireless equipment.
  - Add a low pass EMI filter or a multi winding ferrite core to the DC input cable or AC output cable of the inverter.

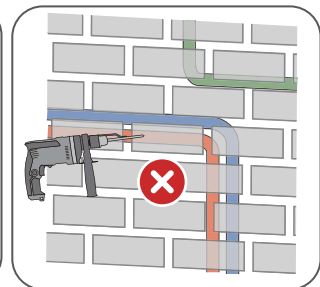

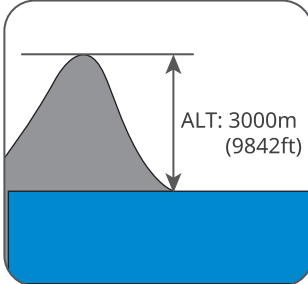
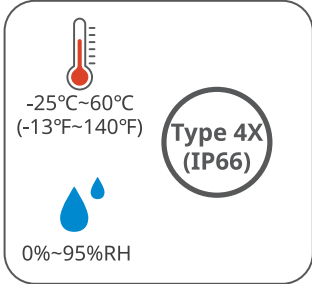
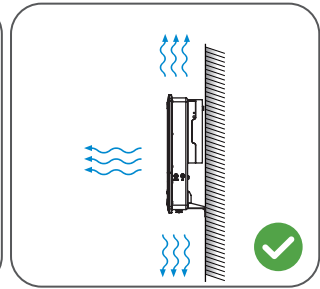
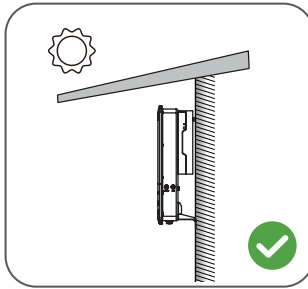
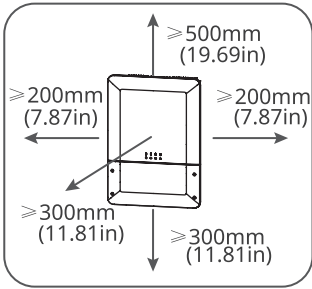

### Mounting Support Requirements

- The mounting support shall be nonflammable and fireproof.
- Make sure that the support surface is solid enough to bear the product weight load.
- Do not install the product on the support with poor sound insulation to avoid the noise generated by the working product, which may annoy the residents nearby.

### Installation Angle Requirements

- Install the inverter vertically or at a maximum back tilt of 15 degrees.
- Do not install the inverter upside down, forward tilt, back forward tilt, or horizontally.

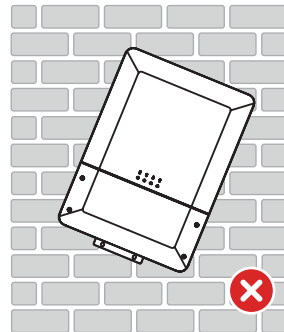
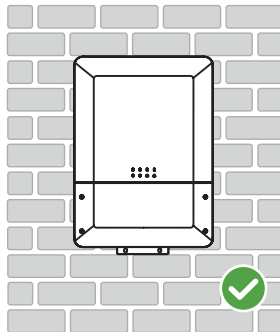
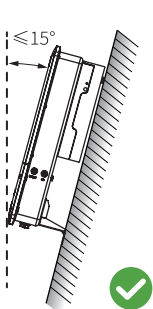

### Installation Tool Requirements

The following tools are recommended when installing the equipment. Use other auxiliary tools on site if necessary.



## 5.2 Inverter Installation

### 5.2.1 Moving the Inverter

#### CAUTION

- Operations such as transportation, turnover, installation and so on must meet the requirements of the laws and regulations of the country or region where it is located.
- Move the inverter to the site before installation. Follow the instructions below to avoid personal injury or equipment damage.
  1. Consider the weight of the equipment before moving it. Assign enough personnel to move the equipment to avoid personal injury.
  2. Wear safety gloves to avoid personal injury.
  3. Keep balance to avoid falling down when moving the equipment.

#### NOTICE

- Avoid the water pipes and cables buried in the wall when drilling holes.
- Wear goggles and a dust mask to prevent the dust from being inhaled or contacting eyes when drilling holes.
- The DC switch lock shall be prepared by customers with hole diameter:  $\varnothing 8\text{mm}$  (0.31in). Select appropriate size. Otherwise it is unable to finish the installation.
- The anti-theft lock shall be prepared by customers with hole diameter:  $\varnothing 10\text{mm}$  (0.39in). Select appropriate size. Otherwise it is unable to finish the installation.
- Make sure the inverter is firmly installed in case of falling down.

**Step 1** Put the mounting plate on the wall or the support horizontally and mark positions for drilling holes.

**Step 2** Drill holes to a depth of 80mm (3.15in) using the hammer drill. The diameter of the drill bit should be 8mm (0.31in).

**Step 3** Secure the mounting plate using the expansion bolts.

**Step 4** Secure the DC switch with the DC switch lock, ensuring that the DC switch is "OFF" during installation.

**Step 5** Install the inverter on the mounting plate.

**Step 6** Tighten the nuts to secure the mounting plate and the inverter. Install the anti-theft lock.

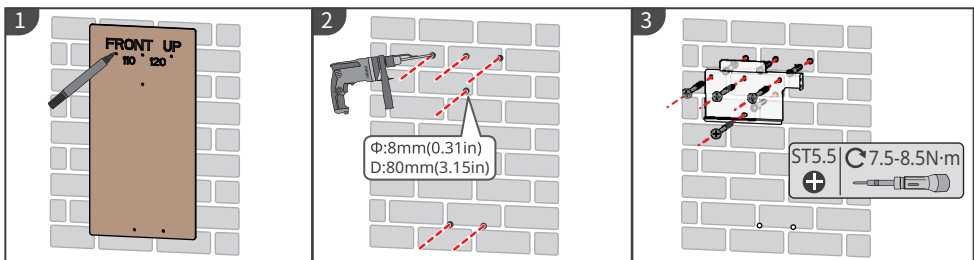

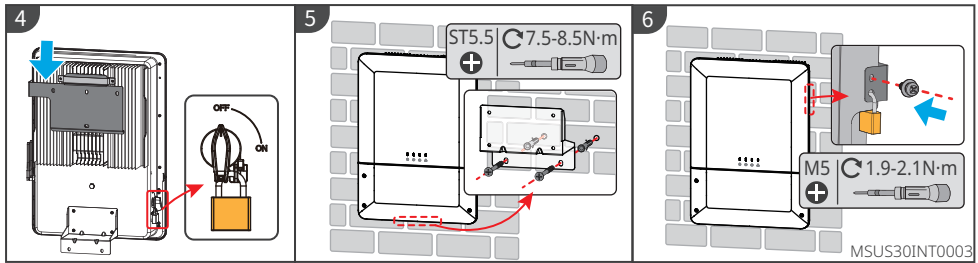

## 6 Electrical Connection

### 6.1 Safety Precaution

#### DANGER

##### INSTRUCTIONS PERTAINING TO A RISK OF FIRE OR ELECTRIC SHOCK

- All operations, cables and parts specification during the electrical connection shall be in compliance with local laws and regulations.
- The input and output circuits are isolated from the enclosure and that system grounding, if required by the National Electric Code, ANSI/NFPA 70, is the responsibility of the installer.
- Disconnect the DC switch and the AC output switch of the inverter to power off the inverter before any electrical connections. Do not work with power on. Otherwise, an electric shock may occur.
- Tie the same type cables together, and place them separately from cables of different types. Do not place the cables entangled or crossed.
- If the cable bears too much tension, the connection may be poor. Reserve a certain length of the cable before connecting it to the inverter cable port.
- When crimping the terminals, ensure that the conductor part of the cable is in full contact with the terminals. Do not crimp the cable jacket with the terminal. Otherwise the inverter may not operate, or its terminal block getting damaged due to heating and other phenomenon because of unreliable connection after operation.

#### WARNING

##### GROUNDING INSTRUCTIONS

- This product must be connected to a grounded, metal, permanent wiring system, or an equipment-grounding conductor must be run with the circuit conductors and connected to the equipment grounding terminal or lead on the product.

#### NOTICE

- Wear personal protective equipment like safety shoes, safety gloves, and insulating gloves during electrical connections.
- All electrical connections should be performed by qualified professionals.
- Cable colors in this document are for reference only. The cable specifications shall meet local laws and regulations.

## 6.2 Preparations before Installation

### 6.2.1 Terminal Introduction

 **WARNING**

- The conduit needs to be provided by the user, and the specification of the conduit used shall match the specification of the waterproof plug.
- It is recommended to use 1 inch cable gland for routing. The diameter for the routing hole on the bottom of the inverter is 28.6mm (1.13 in).
- When installing the conduit, make sure the installation is in place and the hole between the conduit and the inverter interface is sealed. Otherwise the protection level of the equipment may be affected, which may cause damage to the equipment.

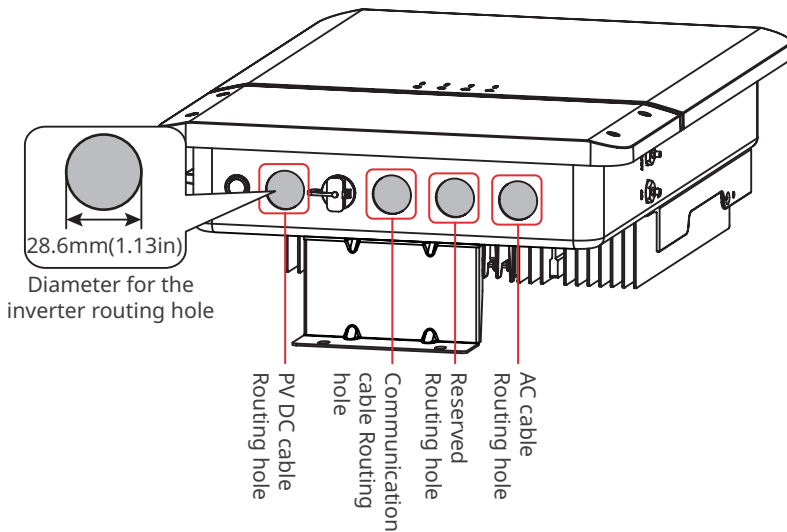

### 6.2.2 Cable Specification

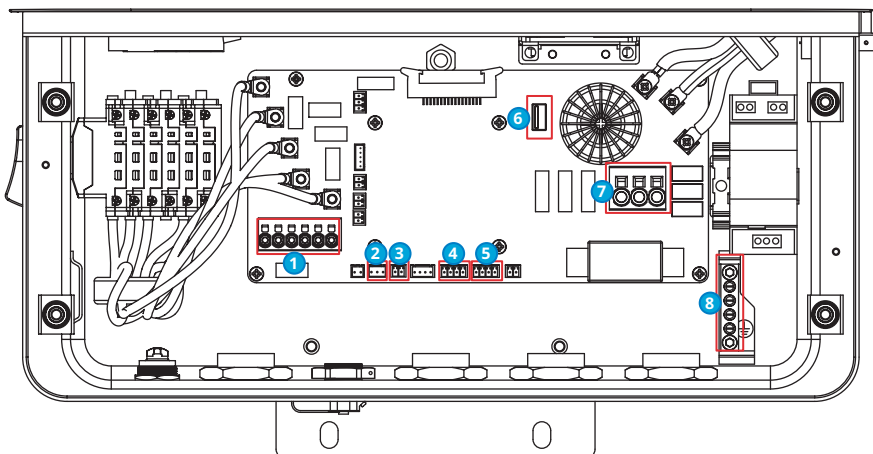

| No. | Port                                 | Screen print                                                                  | Recommended Cable Diameter                                                                                                                                                                                                                                                             |
|-----|--------------------------------------|-------------------------------------------------------------------------------|----------------------------------------------------------------------------------------------------------------------------------------------------------------------------------------------------------------------------------------------------------------------------------------|
| 1   | PV input terminal                    | PV1+ PV1-                                                                     | Used to connect the PV module DC input cables <ul style="list-style-type: none"> <li>The recommended cables are: copper wire, temperature 90°C (194°F), 10AWG</li> </ul>                                                                                                               |
|     |                                      | PV2+ PV2-                                                                     |                                                                                                                                                                                                                                                                                        |
|     |                                      | PV3+ PV3- (only applicable GW7700-MS-US30, GW9600-MS-US30 and GW11K4-MS-US30) |                                                                                                                                                                                                                                                                                        |
| 2   | RS485                                | 485                                                                           | It supports connecting to the upper computer for commissioning. Please contact the after-sales service for detail information.                                                                                                                                                         |
| 3   | Power supply terminal for RSD module | RSD-12V                                                                       | Used to connect the RSD module communication cable <ul style="list-style-type: none"> <li>The recommended cables are: outdoor communication cables meeting UL2919, CM/CMG (NEC type) or CMH (CSA type) standards, with conductor cross-sectional area between 24 and 16AWG.</li> </ul> |
| 4   | Meter communication terminal         | METER                                                                         | Used to connect the meter communication cable. <ul style="list-style-type: none"> <li>The recommended cables are: outdoor communication cables meeting UL2919, CM/CMG (NEC type) or CMH (CSA type) standards, with conductor cross-sectional area between 24 and 16AWG.</li> </ul>     |
| 5   | RS485                                | 485-1<br>485-2                                                                | It supports connecting to the upper computer for commissioning. Please contact the after-sales service for detail information.                                                                                                                                                         |
| 6   | USB port                             | USB                                                                           | The inverter supports connecting with the USB Flash Disk and data cable for local upgrading.                                                                                                                                                                                           |
| 7   | AC cable terminal                    | GRID-L1                                                                       | Used to connect the inverter AC cable. <ul style="list-style-type: none"> <li>The recommended cables are: copper wire, temperature 90°C (194°F), with conductor cross-sectional area 8-6AWG.</li> </ul>                                                                                |
|     |                                      | GRLD-N                                                                        |                                                                                                                                                                                                                                                                                        |
|     |                                      | GRID-L2                                                                       |                                                                                                                                                                                                                                                                                        |
| 8   | Grouding busbar                      | -                                                                             | Connecting the PE cable <ul style="list-style-type: none"> <li>The recommended cables are: copper wire, temperature 90°C (194°F), with conductor cross-sectional area 10-6AWG.</li> </ul>                                                                                              |



### 6.3 Opening the wiring cover

#### NOTICE

- The wrench for opening the inverter lower case cover is distributed with the inverter. After removing the inverter lower case cover, please keep the wrench and fastening screws properly for later use.
- If you need to open the inverter cover in rain or snow, please take protective measures to prevent rain or snow from entering the maintenance chamber. If it is not able to be guaranteed, do not open the inverter cover.
- It is forbidden to open the inverter upper case cover.

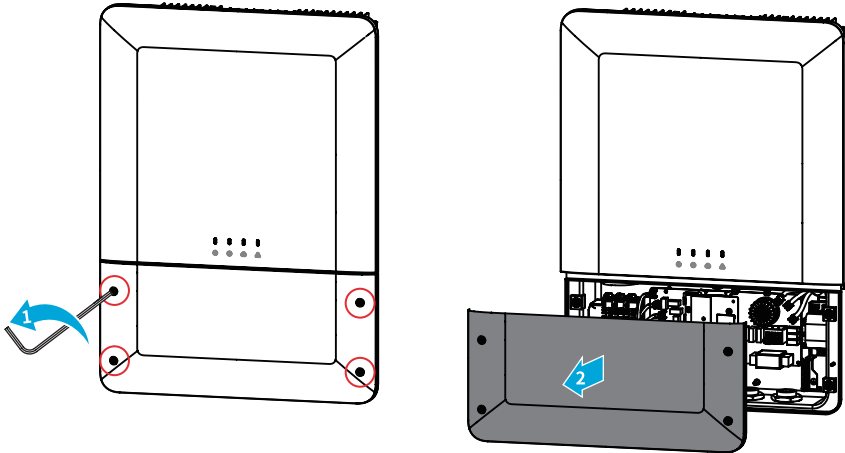

### 6.3 Connecting the PV Input Cable

#### DANGER

##### INSTRUCTIONS PERTAINING TO A RISK OF FIRE OR ELECTRIC SHOCK

- Do not connect one PV string to more than one inverter at the same time. Otherwise, it may cause damages to the inverter.
- Confirm the following information before connecting the PV string to the inverter. Otherwise, the inverter may be damaged permanently or even cause fire and cause personal and property losses.
  1. Make sure that the max short circuit current and the max input voltage per MPPT are within the permissible range.
  2. The recommended MPPT voltage range is within the full-load voltage range. When the MPPT voltage range exceeds 500V, the inverter may automatically reduce output power.
  3. Make sure that the positive pole of the PV string connects to the PV+ of the inverter. And the negative pole of the PV string connects to the PV- of the inverter.

**⚠ WARNING**

The unit is not provided with an isolation transformer and is intended to be installed per NFPA 70, 690.35 with an ungrounded PV array.

- Mixing PV modules of different brands or models in the same MPPT or connecting PV modules with different directions or inclination angles in the same PV string may not necessarily damage the inverter, but may lead to a decrease in the system performance.
- The maximum open-circuit voltage of each PV string cannot exceed 600V.
- It is recommended that the voltage difference between MPPTs shall be less than 200V.
- It is recommended that the sum of the  $I_{mp}$  of the PV strings connected to each MPPT shall not exceed the Max. Input Current per MPPT of the inverter.
- When there are multiple PV strings, it is recommended to maximize the connections of MPPTs.
- The PV strings cannot be grounded. Ensure the minimum isolation resistance of the PV string to the ground meets the minimum isolation resistance requirements before connecting the PV string to the inverter.

**Step 1** Make the DC output cable.

**Step 2** Disassemble the DC routing hole's end cap. Use the cable gland for routing wires. Connect the DC terminals to the inverters.

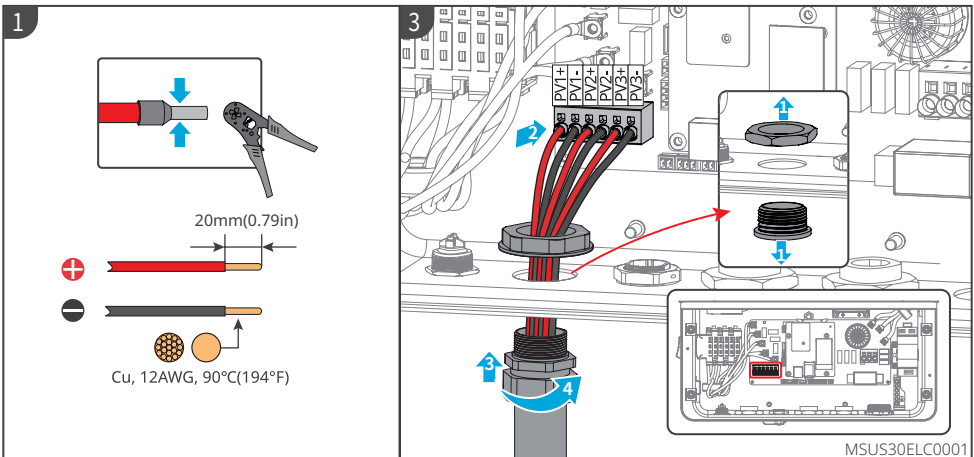

## 6.4 Connecting the AC Output Cable

### WARNING

- Do not connect loads between the inverter and the AC switch directly connected to the inverter.
- The Residual Current Monitoring Unit (RCMU) is integrated into the inverter. The inverter will disconnect the utility grid rapidly once it detects any leak current over the permissible range.

### WARNING

- Pay attention to the silkscreens L1, L2, N, PE on the AC terminal. Connect the AC cables to the corresponding terminals. The inverter may be damaged if the cables are connected inappropriately.
- Make sure that the whole cable cores are inserted into the AC terminal holes. No part of the cable core can be exposed.
- Make sure that the cables are connected securely. Otherwise, the terminal may be too hot to damage the inverter when the inverter is working.

PE terminals need to be provided by customer.

**Step 1** Make the AC output cable.

**Step 2** Disassemble the DC routing hole's end cap. Use the cable gland for routing wires. Plug the AC connector into the inverter.

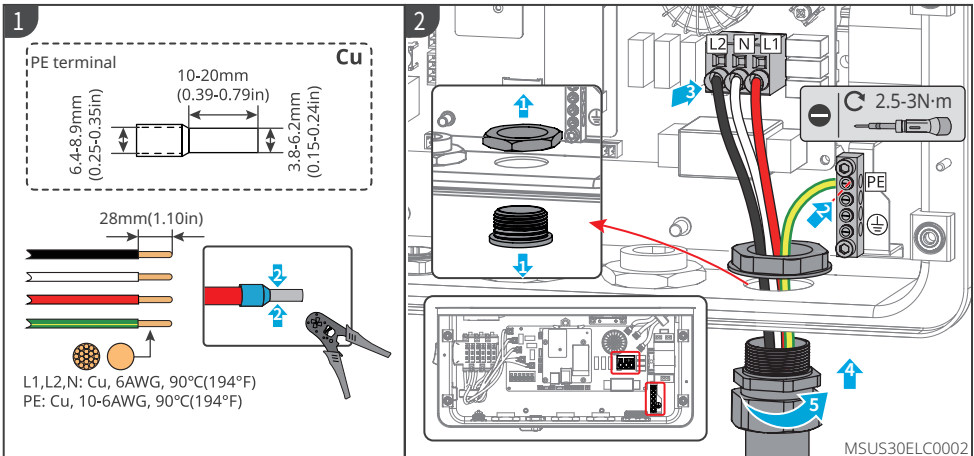

## 6.5 Communication

### 6.5.1 Communication Network Introduction

#### Power Limit Network

The PV station generates power for self-consumption, but the electric equipment cannot consume all the generated power. The inverter can monitor the on-grid electric data in real-time and adjust the output power via a smart meter to avoid the residual current feeding back to the utility grid.

Networking under 240V Nominal Output Voltage

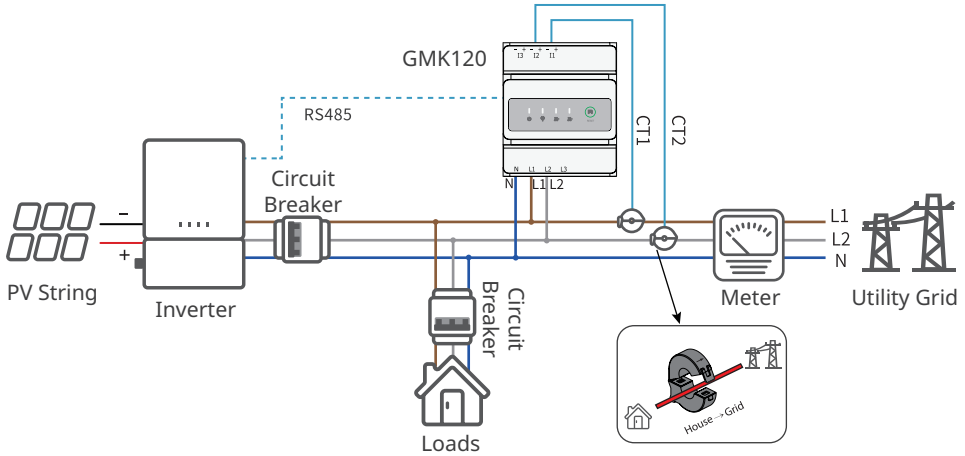

#### NOTICE

After completing cable connections, set related parameters via LCD or SolarGo app to enable export power limit control or output power limit control.

#### Load Monitoring Network

With GMK120, the inverter output data and on-grid data can be accurately measured to calculate the load electricity consumption. The operating data will be uploaded to the Cloud via WiFi or Ezlink communication to realize 24 hours real-time load electricity consumption monitoring.

Networking under 240V Nominal Output Voltage

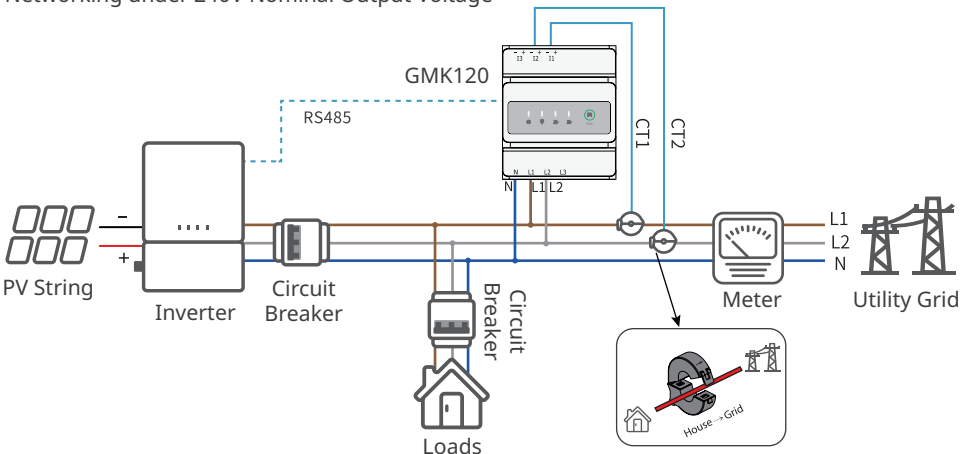

### 6.5.2 Connecting the Communication Cable

#### NOTICE

Make sure that the communication device is connected to the right terminal. Route the communication cable far away from any interference source or power cable to prevent the signal from being influenced.

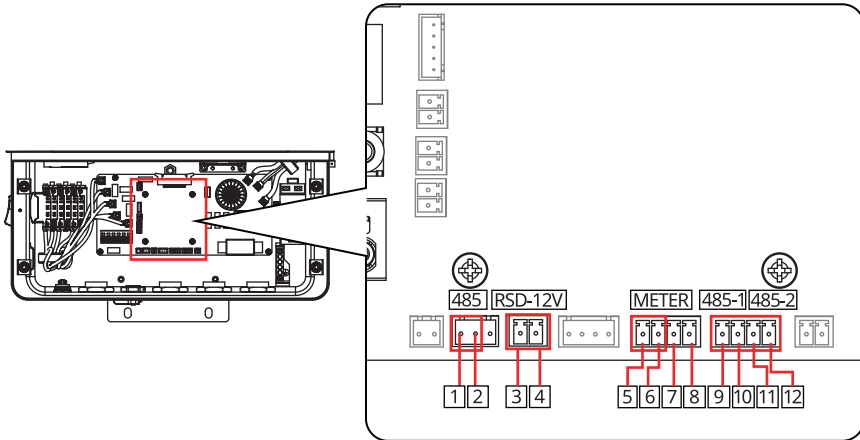

| PIN | Function                    | Definition |
|-----|-----------------------------|------------|
| 1   | RS485                       | RS485_A1   |
| 2   |                             | RS485_B1   |
| 3   | power supply for RSD module | 12V-AC_SPS |
| 4   |                             | RSD-12V    |
| 5   | Meter                       | RS485_A2   |
| 6   |                             | RS485_B2   |
| 7   |                             | Reserved   |
| 8   |                             | Reserved   |
| 9   | RS485                       | RS485_A3   |
| 10  |                             | RS485_B3   |
| 11  |                             | RS485_A4   |
| 12  |                             | RS485_B4   |

**WARNING**

- The communication terminal connected to the power supply port of the RSD switch is equipped with a resistor. When using the RSD function, the resistor needs to be removed and properly stored.
- Do not remove the resistor when the RSD function is not required. Otherwise, the inverter may fail to connect to the power grid.

RSD Wiring Diagram

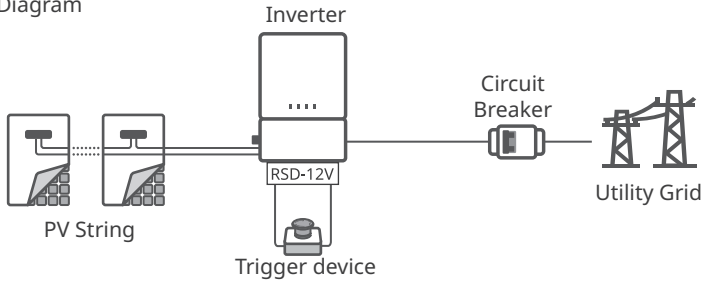

The cables for remote shutdown, smart meter, parallel connection, and power supply for RSD module are connected in the same way. The following illustration shows an example of connecting smart meter communication cable.

**Step 1** Make the communication cable.

**Step 2** Connect the cable with the terminal.

**Step 3** Disassemble the DC routing hole's end cap. Use the cable gland for routing wires. Plug the communication connector into the inverter.

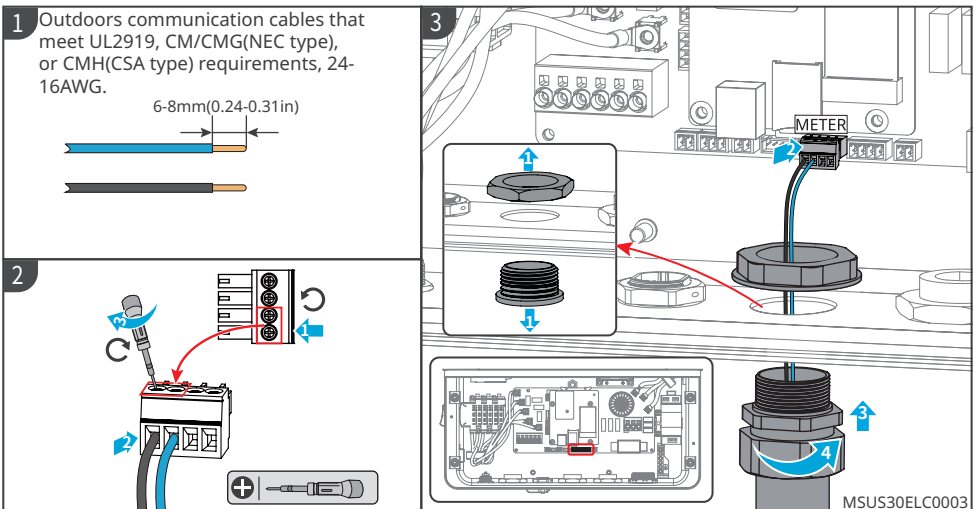

**NOTICE**

- Make sure that the cable is connected correctly and securely. Clear the debris after completing the connection.
- Seal the AC output terminal to ensure the ingress protection rating.

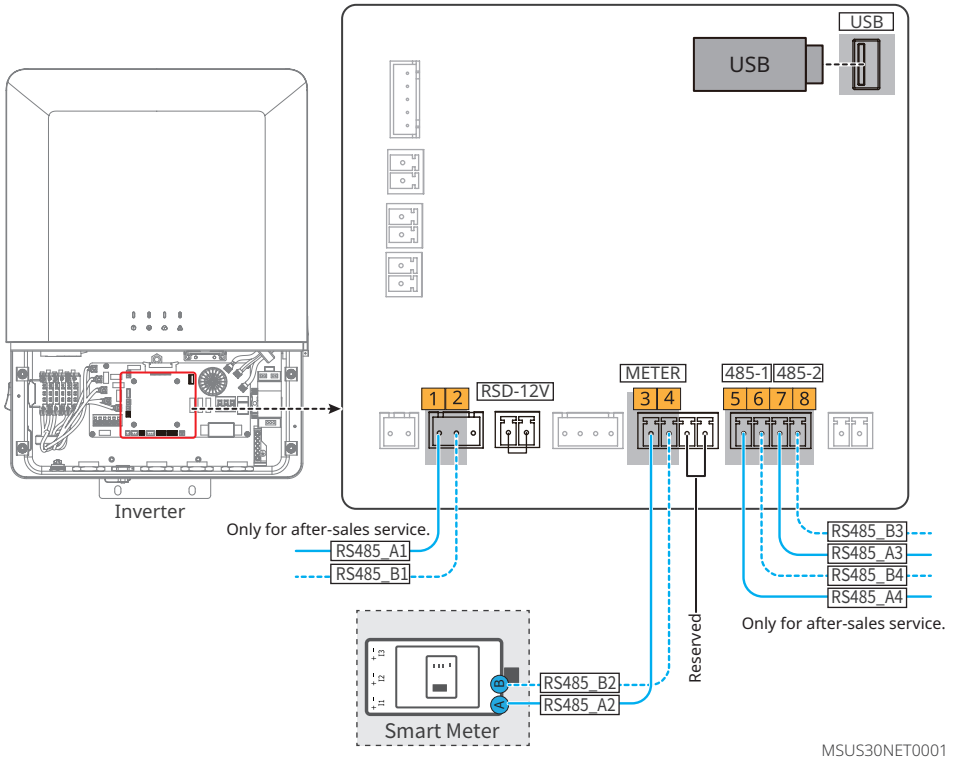

MSUS30NET001

The inverter supports being connected to the smart phone or web pages via Ezlink, WiFi module and WiFi/LAN Kit-20 module to set relative parameters, thus to check the inverter’s running information, fault information and observe system status in time.

### 6.5.3 Connecting the antenna(optional)

#### NOTICE

- When an Ezlink is used for device communication, an antenna needs to be installed.
- The 4G, WiFi, and bluetooth antenna are connected in the same way. The following illustration shows an example of installing the 4G antenna.

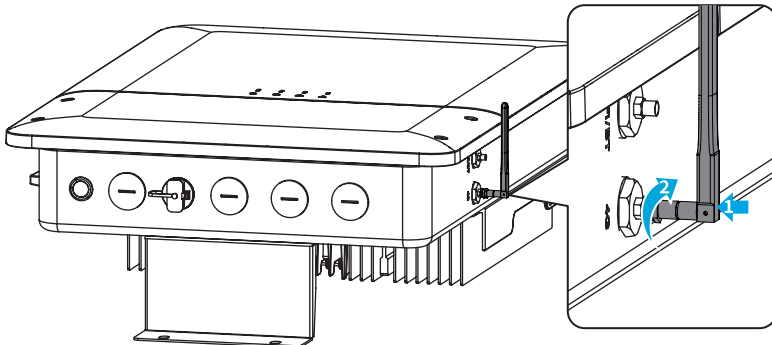

### 6.5.4 Installing the Communication Module (optional)

WiFi Kit, WiFi/LAN Kit-20 modules: optional.

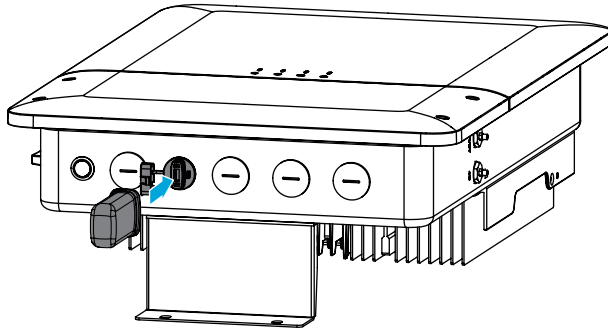

#### NOTICE

- The communication module only applicable to models without built-in Ezlink module.
- Refer to the delivered WiFi module user manual to get more introduction to the module. For more detailed information, visit <https://en.goodwe.com>.



## 7 Equipment Commissioning

### 7.1 Check Before Power ON

| No. | Check Item                                                                                        |
|-----|---------------------------------------------------------------------------------------------------|
| 1   | The product is firmly installed at a clean place that is well-ventilated and easy to operate.     |
| 2   | The PE, DC input, AC output, and communication cables are connected correctly and securely.       |
| 3   | Cable ties are intact, routed properly and evenly.                                                |
| 4   | Unused ports and terminals are sealed.                                                            |
| 5   | The voltage and frequency at the connection point meet the inverter grid connection requirements. |

### 7.2 Power On





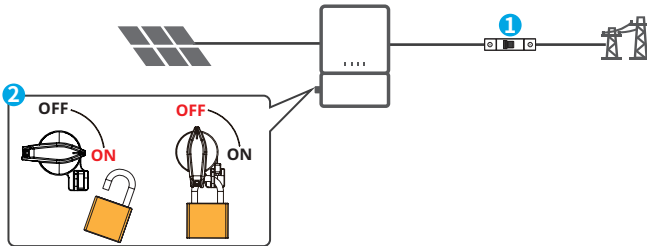













**Step 1** Turn on the AC switch between the inverter and the utility grid.

**Step 2** Turn on the DC switch of the inverter.



## 8 System Commissioning

### 8.1 Indicators and Buttons

| Indicator                                                                         | Status                                                                            | Description                                                  |
|-----------------------------------------------------------------------------------|-----------------------------------------------------------------------------------|--------------------------------------------------------------|
|  |  | ON = Equipment Power On                                      |
|                                                                                   |  | OFF = Equipment Power Off                                    |
|  |  | ON = The Inverter Is Feeding Power                           |
|                                                                                   |  | OFF = The inverter is not feeding power                      |
|                                                                                   |  | Single slow flash = Self check before connecting to the grid |
|                                                                                   |  | Single flash = Connecting to the grid                        |
|  |  | ON = Wireless is connected/active                            |
|                                                                                   |  | Blink 1 = Wireless system is resetting                       |
|                                                                                   |  | Blink 2 = Wireless router not connected                      |
|                                                                                   |  | Blink 4 = Wireless server problem                            |
|                                                                                   |  | Blink = RS485 is connected                                   |
|                                                                                   |  | OFF = Wireless is not active                                 |
|  |  | ON = A fault has occurred                                    |
|                                                                                   |  | OFF = No fault                                               |

## 8.2 Upgrading the Firmware Via USB Flash Disk

**Step 1** Contact the after-sales service to obtain the upgrade package.

**Step 2** Save the upgrade package in the USB flash drive.

**Step 3** Insert the USB flash drive into the USB port, and upgrade the software version of the inverter following the prompts.

## 8.3 Setting Inverter Parameters via SolarGo App

SolarGo app is a mobile application that communicates with the inverter via Bluetooth module, WIFI module or GPRS module. Commonly used functions are as follows:

1. Check the operating data, software version, alarms, etc.
2. Set grid parameters, communication parameters, etc.
3. Equipment maintenance.

For more details, refer to the SolarGo APP User Manual. Scan the QR code or visit [https://en.goodwe.com/Ftp/EN/Downloads/User%20Manual/GW\\_SolarGo\\_User%20Manual-EN.pdf](https://en.goodwe.com/Ftp/EN/Downloads/User%20Manual/GW_SolarGo_User%20Manual-EN.pdf) to get the user manual.



SolarGo App



SolarGo App User  
Manual

## 8.4 Monitoring via SEMS Portal

SEMS Portal is an monitoring platform used to manage organizations/users, add plants, and monitor plant status.

For more details, refer to the SEMS Portal User Manual. Scan the QR code or visit [https://en.goodwe.com/Ftp/EN/Downloads/User%20Manual/GW\\_SEMS%20Portal-User%20Manual-EN.pdf](https://en.goodwe.com/Ftp/EN/Downloads/User%20Manual/GW_SEMS%20Portal-User%20Manual-EN.pdf) to get the user manual.



SEMS Portal



SEMS Portal User  
Manual

## 9 Maintenance

### 9.1 Power Off the Inverter

#### DANGER

INSTRUCTIONS PERTAINING TO A RISK OF FIRE OR ELECTRIC SHOCK

- Power off the inverter before operations and maintenance. Otherwise, the inverter may be damaged or electric shocks may occur.
- Delayed discharge. Wait until the components are discharged after power off.

**Step 1 (Optional)** Send the Remote shutdown command to the inverter through SolarGo App.

**Step 2** Turn off the AC switch between the inverter and the utility grid.

**Step 3** Turn off the DC switch of the inverter.

### 9.2 Removing the Inverter

#### WARNING

- Make sure that the inverter is powered off.
- Wear proper PPE before any operations.

**Step 1** Disconnect all the cables, including DC cables, AC cables, communication cables, the communication module, and PE cables.

**Step 2** Grab the handles or hoist the inverter to remove the inverter from the mounting plate.

**Step 3** Remove the mounting plate.

**Step 4** Store the inverter properly. If the inverter needs to be used later, ensure that the storage conditions meet the requirements.

### 9.3 Disposing of the Inverter

If the inverter cannot work anymore, dispose of it according to the local disposal requirements for electrical equipment waste. The inverter cannot be disposed of together with household waste.

### 9.4 Troubleshooting

Perform troubleshooting according to the following methods. Contact the after-sales service if these methods do not work.

Collect the information below before contacting the after-sales service, so that the problems can be solved quickly.

1. Inverter information like serial number, software version, installation date, fault time, fault frequency, etc.
2. Installation environment, including weather conditions, whether the PV modules are sheltered or shadowed, etc. It is recommended to provide some photos and videos to assist in analyzing the problem.
3. Utility grid situation.

| No. | Fault                  | Cause                                                                                                            | Solutions                                                                                                                                                                                                                                                                                                                                                                                                                                                                                                                                                                                                                                                                                                                                                                  |
|-----|------------------------|------------------------------------------------------------------------------------------------------------------|----------------------------------------------------------------------------------------------------------------------------------------------------------------------------------------------------------------------------------------------------------------------------------------------------------------------------------------------------------------------------------------------------------------------------------------------------------------------------------------------------------------------------------------------------------------------------------------------------------------------------------------------------------------------------------------------------------------------------------------------------------------------------|
| 1   | Utility Loss           | 1. Utility grid power fails.<br>2. The AC cable is disconnected, or the AC breaker is off.                       | 1. The alarm is automatically cleared after the grid power supply is restored.<br>2. Check whether the AC cable is connected and the AC breaker is on.                                                                                                                                                                                                                                                                                                                                                                                                                                                                                                                                                                                                                     |
| 2   | Grid Overvoltage       | The grid voltage exceeds the permissible range, or the duration of high voltage exceeds the requirement of HVRT. | 1. If the problem occurs occasionally, the utility grid may be abnormal temporarily. The inverter will recover automatically after detecting that the utility grid is normal.<br>2. If the problem occurs frequently, check whether the grid voltage is within the permissible range. <ul style="list-style-type: none"> <li>• Contact the local power company if the grid voltage exceeds the permissible range.</li> <li>• Modify the overvoltage protection threshold, HVRT or disable the overvoltage protection function after obtaining the consent of the local power company if the grid frequency is within the permissible range.</li> </ul> 3. Check whether the AC breaker and the output cables are connected securely and correctly if the problem persists. |
| 3   | Grid Rapid Overvoltage | The grid voltage is abnormal or ultra-high.                                                                      | 1. If the problem occurs occasionally, the utility grid may be abnormal temporarily. The inverter will recover automatically after detecting that the utility grid is normal.<br>2. If the problem occurs frequently, check whether the grid voltage is within the allowed range. <ul style="list-style-type: none"> <li>• Contact the local power company if the grid voltage exceeds the permissible range.</li> <li>• Modify the grid overvoltage rapid protection threshold after obtaining the consent of the local power company if the grid voltage is within the permissible range.</li> </ul>                                                                                                                                                                     |

| No. | Fault                  | Cause                                                                                                                 | Solutions                                                                                                                                                                                                                                                                                                                                                                                                                                                                                                                                                                                                                                                                                                                                                                                                                                                                  |
|-----|------------------------|-----------------------------------------------------------------------------------------------------------------------|----------------------------------------------------------------------------------------------------------------------------------------------------------------------------------------------------------------------------------------------------------------------------------------------------------------------------------------------------------------------------------------------------------------------------------------------------------------------------------------------------------------------------------------------------------------------------------------------------------------------------------------------------------------------------------------------------------------------------------------------------------------------------------------------------------------------------------------------------------------------------|
| 4   | Grid Undervoltage      | The grid voltage is lower than the permissible range, or the duration of low voltage exceeds the requirement of LVRT. | <ol style="list-style-type: none"> <li>1. If the problem occurs occasionally, the utility grid may be abnormal temporarily. The inverter will recover automatically after detecting that the utility grid is normal.</li> <li>2. If the problem occurs frequently, check whether the grid voltage is within the permissible range.                             <ul style="list-style-type: none"> <li>• Contact the local power company if the grid voltage exceeds the permissible range.</li> <li>• Modify the undervoltage protection threshold, LVRT or disable the undervoltage protection function after obtaining the consent of the local power company if the grid frequency is within the permissible range.</li> </ul> </li> <li>3. Check whether the AC breaker and the output cables are connected securely and correctly if the problem persists.</li> </ol> |
| 5   | Grid 10min Overvoltage | The moving average of grid voltage in 10min exceeds the range of safety requirements.                                 | <ol style="list-style-type: none"> <li>1. If the problem occurs occasionally, the utility grid may be abnormal temporarily. The inverter will recover automatically after detecting that the utility grid is normal.</li> <li>2. If the problem occurs frequently, check whether the grid voltage is within the permissible range.                             <ul style="list-style-type: none"> <li>• Contact the local power company if the grid voltage exceeds the permissible range.</li> <li>• Modify the 10min overvoltage protection threshold with the consent of the local power company if the grid voltage is within the permissible range.</li> </ul> </li> </ol>                                                                                                                                                                                            |

| No. | Fault                      | Cause                                                                                                                   | Solutions                                                                                                                                                                                                                                                                                                                                                                                                                                                                                                                                                                                                                                                                                                           |
|-----|----------------------------|-------------------------------------------------------------------------------------------------------------------------|---------------------------------------------------------------------------------------------------------------------------------------------------------------------------------------------------------------------------------------------------------------------------------------------------------------------------------------------------------------------------------------------------------------------------------------------------------------------------------------------------------------------------------------------------------------------------------------------------------------------------------------------------------------------------------------------------------------------|
| 6   | Grid Overfrequency         | Utility grid exception. The actual grid frequency exceeds the requirement of the local grid standard.                   | <ol style="list-style-type: none"> <li>1. If the problem occurs occasionally, the utility grid may be abnormal temporarily. The inverter will recover automatically after detecting that the utility grid is normal.</li> <li>2. If the problem occurs frequently, check whether the grid frequency is within the permissible range. <ul style="list-style-type: none"> <li>• Contact the local power company if the grid frequency exceeds the permissible range.</li> <li>• Modify the overfrequency protection threshold or disable the overfrequency protection function after obtaining the consent of the local power company if the grid frequency is within the permissible range.</li> </ul> </li> </ol>   |
| 7   | Grid Underfrequency        | Utility grid exception. The actual grid frequency is lower than the requirement of the local grid standard.             | <ol style="list-style-type: none"> <li>1. If the problem occurs occasionally, the utility grid may be abnormal temporarily. The inverter will recover automatically after detecting that the utility grid is normal.</li> <li>2. If the problem occurs frequently, check whether the grid frequency is within the permissible range. <ul style="list-style-type: none"> <li>• Contact the local power company if the grid frequency exceeds the permissible range.</li> <li>• Modify the underfrequency protection threshold or disable the underfrequency protection function after obtaining the consent of the local power company if the grid frequency is within the permissible range.</li> </ul> </li> </ol> |
| 8   | Grid Frequency Instability | Utility grid exception. The actual grid frequency change rate does not meet the requirement of the local grid standard. | <ol style="list-style-type: none"> <li>1. If the problem occurs occasionally, the utility grid may be abnormal temporarily. The inverter will recover automatically after detecting that the utility grid is normal.</li> <li>2. If the problem occurs frequently, check whether the grid frequency is within the permissible range. <ul style="list-style-type: none"> <li>• Contact the local power company if the grid frequency exceeds the permissible range.</li> <li>• Contact the dealer or the after-sales service if the grid frequency is within the permissible range.</li> </ul> </li> </ol>                                                                                                           |

| No. | Fault                     | Cause                                                                                                                                                        | Solutions                                                                                                                                                                                                                                                                                                                                                                                                                                       |
|-----|---------------------------|--------------------------------------------------------------------------------------------------------------------------------------------------------------|-------------------------------------------------------------------------------------------------------------------------------------------------------------------------------------------------------------------------------------------------------------------------------------------------------------------------------------------------------------------------------------------------------------------------------------------------|
| 9   | Anti-islanding            | The utility grid is disconnected. The utility grid is disconnected according to the safety regulations, but the grid voltage is maintained due to the loads. | <ol style="list-style-type: none"> <li>1. Check whether the utility grid is disconnected.</li> <li>2. Contact the dealer or the after-sales service.</li> </ol>                                                                                                                                                                                                                                                                                 |
| 10  | LVRT Undervoltage         | Utility grid exception. The duration of the utility grid exception exceeds the set time of LVRT.                                                             | <ol style="list-style-type: none"> <li>1. If the problem occurs occasionally, the utility grid may be abnormal temporarily. The inverter will recover automatically after detecting that the utility grid is normal.</li> <li>2. If the problem occurs frequently, check whether the grid frequency is within the permissible range. If not, contact the local power company. If yes, contact the dealer or the after-sales service.</li> </ol> |
| 11  | HVRT Overvoltage          | Utility grid exception. The duration of utility grid exception exceeds the set time of HVRT.                                                                 | <ol style="list-style-type: none"> <li>2. If the problem occurs frequently, check whether the grid frequency is within the permissible range. If not, contact the local power company. If yes, contact the dealer or the after-sales service.</li> </ol>                                                                                                                                                                                        |
| 12  | Abnormal GFCI 30mA        | The input insulation impedance becomes low when the inverter is working.                                                                                     | <ol style="list-style-type: none"> <li>1. If the problem occurs occasionally, it may be caused by a cable exception. The inverter will recover automatically after the problem is solved.</li> <li>2. Check whether the impedance between the PV string and PE is too low if the problem occurs frequently or persists.</li> </ol>                                                                                                              |
| 13  | Abnormal GFCI 60mA        |                                                                                                                                                              |                                                                                                                                                                                                                                                                                                                                                                                                                                                 |
| 14  | Abnormal GFCI 150mA       |                                                                                                                                                              |                                                                                                                                                                                                                                                                                                                                                                                                                                                 |
| 15  | Abnormal GFCI             |                                                                                                                                                              |                                                                                                                                                                                                                                                                                                                                                                                                                                                 |
| 16  | Large DC of AC current L1 | The DC component of the output current exceeds the safety range or default range.                                                                            | <ol style="list-style-type: none"> <li>1. If the problem is caused by an external fault like a utility grid exception or frequency exception, the inverter will recover automatically after solving the problem.</li> <li>2. If the problem occurs frequently and the PV station cannot work properly, contact the dealer or the after-sales service.</li> </ol>                                                                                |
| 17  | Large DC of AC current L2 |                                                                                                                                                              |                                                                                                                                                                                                                                                                                                                                                                                                                                                 |



| No. | Fault                      | Cause                                                                                                                                                                                                                                                                                | Solutions                                                                                                                                                                                                                                                                                                     |
|-----|----------------------------|--------------------------------------------------------------------------------------------------------------------------------------------------------------------------------------------------------------------------------------------------------------------------------------|---------------------------------------------------------------------------------------------------------------------------------------------------------------------------------------------------------------------------------------------------------------------------------------------------------------|
| 18  | Low Insulation Res.        | <ol style="list-style-type: none"> <li>1. The PV string is short-circuited to PE.</li> <li>2. The PV system is in a moist environment and the cable is not well insulated to the ground.</li> </ol>                                                                                  | <ol style="list-style-type: none"> <li>1. Check whether the resistance of the PV string to PE exceeds 50kΩ. If no, check the short circuit point.</li> <li>2. Check whether the PE cable is connected correctly.</li> <li>3. If the resistance is lower on rainy days, please reset the ISO.</li> </ol>       |
| 19  | Abnormal Ground            | <ol style="list-style-type: none"> <li>1. The PE cable of the inverter is not connected well.</li> <li>2. The L cable and N cable are connected reversely when output of the PV string is grounded.</li> </ol>                                                                       | <ol style="list-style-type: none"> <li>1. Check whether the PE cable of the inverter is connected properly.</li> <li>2. Check whether the L cable and N cable are connected reversely if output of the PV string is grounded.</li> </ol>                                                                      |
| 20  | Anti Reverse power Failure | Abnormal fluctuation of load                                                                                                                                                                                                                                                         | <ol style="list-style-type: none"> <li>1. If the exception is caused by an external fault, the inverter will recover automatically after solving the problem.</li> <li>2. If the problem occurs frequently and the PV station cannot work properly, contact the dealer or the after-sales service.</li> </ol> |
| 21  | Internal Comm Loss         | <ol style="list-style-type: none"> <li>1. Frame format error</li> <li>2. Parity checking error</li> <li>3. Can bus offline</li> <li>4. Hardware CRC error</li> <li>5. Send (receive) control bit is receive (send).</li> <li>6. Transmit to the unit that is not allowed.</li> </ol> | <p>Disconnect the AC output switch and DC input switch, then connect them 5 minutes later. Contact the dealer or the after-sales service if the problem persists.</p>                                                                                                                                         |
| 22  | AC HCT Check abnormal      | The sampling of the AC HCT is abnormal.                                                                                                                                                                                                                                              | <p>Disconnect the AC output switch and DC input switch, then connect them 5 minutes later. Contact the dealer or the after-sales service if the problem persists.</p>                                                                                                                                         |

| No. | Fault                   | Cause                                                                                                                                                                                                                                    | Solutions                                                                                                                                                                                                                                                                                                                                                                            |
|-----|-------------------------|------------------------------------------------------------------------------------------------------------------------------------------------------------------------------------------------------------------------------------------|--------------------------------------------------------------------------------------------------------------------------------------------------------------------------------------------------------------------------------------------------------------------------------------------------------------------------------------------------------------------------------------|
| 23  | GFCI HCT Check abnormal | The sampling of the GFCI HCT is abnormal.                                                                                                                                                                                                | Disconnect the AC output switch and DC input switch, then connect them 5 minutes later. Contact the dealer or the after-sales service if the problem persists.                                                                                                                                                                                                                       |
| 24  | Relay Check abnormal    | <ol style="list-style-type: none"> <li>1. The relay is abnormal or short-circuited.</li> <li>2. The control circuit is abnormal.</li> <li>3. The AC cable connection is abnormal, like a virtual connection or short circuit.</li> </ol> | Disconnect the AC output switch and DC input switch, then connect them 5 minutes later. Contact the dealer or the after-sales service if the problem persists.                                                                                                                                                                                                                       |
| 25  | Internal Fan abnormal   | <ol style="list-style-type: none"> <li>1. The fan power supply is abnormal.</li> <li>2. Mechanical exception.</li> <li>3. The fan is aging and damaged.</li> </ol>                                                                       | Disconnect the AC output switch and DC input switch, then connect them 5 minutes later. Contact the dealer or the after-sales service if the problem persists.                                                                                                                                                                                                                       |
| 26  | Flash Fault             | The internal Flash storage is abnormal.                                                                                                                                                                                                  | Disconnect the AC output switch and DC input switch, then connect them 5 minutes later. Contact the dealer or the after-sales service if the problem persists.                                                                                                                                                                                                                       |
| 27  | DC Arc Fault            | <ol style="list-style-type: none"> <li>1. The DC terminal is not firmly connected.</li> <li>2. The DC cable is broken.</li> </ol>                                                                                                        | Read the Quick Installation Guide and check whether the cables are connected properly.                                                                                                                                                                                                                                                                                               |
| 28  | AFCI Self-test Fault    | AFCI detection is abnormal.                                                                                                                                                                                                              | Disconnect the AC output switch and DC input switch, then connect them 5 minutes later. Contact the dealer or the after-sales service if the problem persists.                                                                                                                                                                                                                       |
| 29  | Cavity Overtemperature  | <ol style="list-style-type: none"> <li>1. The inverter is installed in a place with poor ventilation.</li> <li>2. The ambient temperature exceeds 60°C.</li> <li>3. A fault occurs in the internal fan of the inverter.</li> </ol>       | <ol style="list-style-type: none"> <li>1. Check the ventilation and the ambient temperature at the installation point.</li> <li>2. If the ventilation is poor or the ambient temperature is too high, improve the ventilation and heat dissipation.</li> <li>3. Contact the dealer or after-sales service if both the ventilation and the ambient temperature are normal.</li> </ol> |

| No. | Fault                              | Cause                                                                                                                                              | Solutions                                                                                                                                                               |
|-----|------------------------------------|----------------------------------------------------------------------------------------------------------------------------------------------------|-------------------------------------------------------------------------------------------------------------------------------------------------------------------------|
| 30  | BUS Overvoltage                    | <ol style="list-style-type: none"> <li>1. The PV voltage is too high.</li> <li>2. The sampling of the inverter BUS voltage is abnormal.</li> </ol> | Disconnect the AC output switch and DC input switch, then connect them 5 minutes later. Contact the dealer or the after-sales service if the problem persists.          |
| 31  | PV Input Overvoltage               | The PV array configuration is not correct. Too many PV panels are connected in series in the PV string.                                            | Check the serial connection of the PV array. Make sure that the open circuit voltage of the PV string is not higher than the maximum operating voltage of the inverter. |
| 32  | PV Continuous Hardware Overcurrent | <ol style="list-style-type: none"> <li>1. The PV configuration is not proper.</li> <li>2. The hardware is damaged.</li> </ol>                      | Disconnect the AC output switch and DC input switch, then connect them 5 minutes later. Contact the dealer or the after-sales service if the problem persists.          |
| 33  | PV Continuous Software Overcurrent | <ol style="list-style-type: none"> <li>1. The PV configuration is not proper.</li> <li>2. The hardware is damaged.</li> </ol>                      | Disconnect the AC output switch and DC input switch, then connect them 5 minutes later. Contact the dealer or the after-sales service if the problem persists.          |
| 34  | String1 PV String Reversed         | The PV string is connected reversely.                                                                                                              | Check whether the PV1 and PV2 strings are connected reversely.                                                                                                          |
| 35  | String2 PV String Reversed         |                                                                                                                                                    |                                                                                                                                                                         |

## 9.5 Routine Maintenance

 **WARNING**

- Make sure that the inverter is powered off.
- Wear proper PPE before any operations.

| Maintaining Item      | Maintaining Method                                                                                                                | Maintaining Period |
|-----------------------|-----------------------------------------------------------------------------------------------------------------------------------|--------------------|
| System Clean          | Check the heat sink, air intake, and air outlet for foreign matter or dust.                                                       | Once 6-12 months   |
| DC Switch             | Turn the DC switch on and off ten consecutive times to make sure that it is working properly.                                     | Once a year        |
| Electrical Connection | Check whether the cables are securely connected. Check whether the cables are broken or whether there is any exposed copper core. | Once 6-12 months   |
| Sealing               | Check whether all the terminals and ports are properly sealed. Reseal the cable hole if it is not sealed or too big.              | Once a year        |

## 10 Technical Parameters

| Technical Data                                                  | GW5000-MS-US30 | GW6000-MS-US30 | GW7600-MS-US30 |
|-----------------------------------------------------------------|----------------|----------------|----------------|
| <b>Input</b>                                                    |                |                |                |
| Max.Input Power (W)                                             | 8,000          | 9,600          | 12,160         |
| Max. Input Voltage (V) <sup>*1</sup>                            | 600            | 600            | 600            |
| MPPT Operating Voltage Range (V) <sup>*2</sup>                  | 65-550         | 65-550         | 65-550         |
| MPPT Voltage Range at Nominal Power (V) (at 240V) <sup>*2</sup> | 165-500        | 198-500        | 250-500        |
| MPPT Voltage Range at Nominal Power (V) (at 208V) <sup>*2</sup> | 143-500        | 171-500        | 217-500        |
| Start-up Voltage (V)                                            | 80             | 80             | 80             |
| Nominal Input Voltage (V) (at 240V)                             | 380            | 380            | 380            |
| Nominal Input Voltage (V) (at 208V)                             | 330            | 330            | 330            |
| Max. Input Current per MPPT (A)                                 | 16             | 16             | 16             |
| Max. Short Circuit Current per MPPT (A)                         | 23.4           | 23.4           | 23.4           |
| Max.Backfeed Current to The Array (A)                           | 0              | 0              | 0              |
| Number of MPP trackers                                          | 2              | 2              | 2              |
| Number of Strings per MPPT                                      | 1              | 1              | 1              |
| <b>Output</b>                                                   |                |                |                |
| Nominal Output Power (W) (at 240V)                              | 5,000          | 6,000          | 7,600          |
| Nominal Output Power (W) (at 208V)                              | 4,333          | 5,200          | 6,580          |
| Nominal Output Apparent Power (VA)(at 240V)                     | 5,000          | 6,000          | 7,600          |
| Nominal Output Apparent Power (VA)(at 208V)                     | 4,333          | 5,200          | 6,580          |
| Max. AC Active Power (W)(at 240V)                               | 5,000          | 6,000          | 7,600          |
| Max. AC Active Power (W)(at 208V)                               | 4,333          | 5,200          | 6,580          |
| Max. AC Apparent Power (VA) (at 240V)                           | 5,000          | 6,000          | 7,600          |
| Max. AC Apparent Power (VA) (at 208V)                           | 4,333          | 5,200          | 6,580          |
| Nominal Output Voltage (V)                                      | 240/208        | 240/208        | 240/208        |

| Technical Data                                                | GW5000-MS-US30                                  | GW6000-MS-US30                           | GW7600-MS-US30                           |
|---------------------------------------------------------------|-------------------------------------------------|------------------------------------------|------------------------------------------|
| Output Voltage Range (V)(at 240V)                             | 211~264<br>(according to local standard)        | 211~264<br>(according to local standard) | 211~264<br>(according to local standard) |
| Output Voltage Range (V)(at 208V)                             | 183~229<br>(according to local standard)        | 183~229<br>(according to local standard) | 183~229<br>(according to local standard) |
| Nominal AC Grid Frequency (Hz)                                | 60                                              | 60                                       | 60                                       |
| AC Grid Frequency Range (Hz)                                  | 58~62                                           | 58~62                                    | 58~62                                    |
| Max. Output Current (A)                                       | 20.8                                            | 25.0                                     | 31.7                                     |
| Max. Output Fault Current (Peak and Duration) (A/ms)(at 20us) | 68                                              | 68                                       | 68                                       |
| Inrush Current (Peak and Duration) (A/us)(at 20us)            | 58                                              | 58                                       | 58                                       |
| Nominal Output Current (A)                                    | 20.8                                            | 25.0                                     | 31.7                                     |
| Power Factor                                                  | ~1 (Adjustable from 0.8 leading to 0.8 lagging) |                                          |                                          |
| Max. Total Harmonic Distortion                                | <3%                                             |                                          |                                          |
| Maximum Output Overcurrent Protection (A)                     | 68                                              | 68                                       | 68                                       |
| <b>Efficiency</b>                                             |                                                 |                                          |                                          |
| Max. Efficiency                                               | 97.5%                                           | 97.5%                                    | 97.5%                                    |
| CEC Efficiency(at 240V)                                       | 96.5%                                           | 96.5%                                    | 96.5%                                    |
| CEC Efficiency(at 208V)                                       | 96.0%                                           | 96.0%                                    | 96.5%                                    |
| <b>Protection</b>                                             |                                                 |                                          |                                          |
| PV String Current Monitoring                                  | Integrated                                      |                                          |                                          |
| PV Insulation Resistance Detection                            | Integrated                                      |                                          |                                          |
| Residual Current Monitoring                                   | Integrated                                      |                                          |                                          |
| PV Reverse Polarity Protection                                | Integrated                                      |                                          |                                          |
| Anti-islanding Protection                                     | Integrated                                      |                                          |                                          |
| AC Overcurrent Protection                                     | Integrated                                      |                                          |                                          |
| AC Short Circuit Protection                                   | Integrated                                      |                                          |                                          |
| AC Overvoltage Protection                                     | Integrated                                      |                                          |                                          |
| DC Switch                                                     | Integrated                                      |                                          |                                          |
| DC Surge Protection                                           | Type III (Type II Optional)                     |                                          |                                          |
| AC Surge Protection                                           | Type III (Type II Optional)                     |                                          |                                          |
| AFCI                                                          | Integrated                                      |                                          |                                          |
| Rapid Shutdown                                                | Integrated                                      |                                          |                                          |
| Power Supply at Night                                         | Integrated                                      |                                          |                                          |
| <b>General Data</b>                                           |                                                 |                                          |                                          |

| Technical Data                                                                                                                                                                                                                                                                                                                                                                                                                                                                                                                            | GW5000-MS-US30                           | GW6000-MS-US30 | GW7600-MS-US30 |
|-------------------------------------------------------------------------------------------------------------------------------------------------------------------------------------------------------------------------------------------------------------------------------------------------------------------------------------------------------------------------------------------------------------------------------------------------------------------------------------------------------------------------------------------|------------------------------------------|----------------|----------------|
| Operating Temperature Range (°F)                                                                                                                                                                                                                                                                                                                                                                                                                                                                                                          | -31~140 (-35~60°C)                       |                |                |
| Derating temperature (°F)                                                                                                                                                                                                                                                                                                                                                                                                                                                                                                                 | 113 (45°C)                               |                |                |
| Storage Temperature Range (°F)                                                                                                                                                                                                                                                                                                                                                                                                                                                                                                            | -40~ +158 (-40~+70 °C)                   |                |                |
| Relative Humidity                                                                                                                                                                                                                                                                                                                                                                                                                                                                                                                         | 0~95%                                    |                |                |
| Max. Operating Altitude (ft)                                                                                                                                                                                                                                                                                                                                                                                                                                                                                                              | 9842 (3000m)                             |                |                |
| Cooling Method                                                                                                                                                                                                                                                                                                                                                                                                                                                                                                                            | Natural Convection                       |                |                |
| Display                                                                                                                                                                                                                                                                                                                                                                                                                                                                                                                                   | LED, WLAN+APP                            |                |                |
| Communication                                                                                                                                                                                                                                                                                                                                                                                                                                                                                                                             | RS485, WiFi+LAN+Bluetooth, 4G (Optional) |                |                |
| Weight (Ib)                                                                                                                                                                                                                                                                                                                                                                                                                                                                                                                               | 51.8 (23.0kg)                            |                |                |
| Dimension (W×H×D in)                                                                                                                                                                                                                                                                                                                                                                                                                                                                                                                      | 19.2×26.4×7.8(487×670×199mm)             |                |                |
| Noise Emission (dB)                                                                                                                                                                                                                                                                                                                                                                                                                                                                                                                       | <25                                      |                |                |
| Topology                                                                                                                                                                                                                                                                                                                                                                                                                                                                                                                                  | Non-isolated                             |                |                |
| Self-consumption at Night (W)                                                                                                                                                                                                                                                                                                                                                                                                                                                                                                             | <5                                       |                |                |
| Ingress Protection Rating                                                                                                                                                                                                                                                                                                                                                                                                                                                                                                                 | Type 4X (IP66)                           |                |                |
| Anti-corrosion Class                                                                                                                                                                                                                                                                                                                                                                                                                                                                                                                      | C4                                       |                |                |
| Environmental Category                                                                                                                                                                                                                                                                                                                                                                                                                                                                                                                    | 4K4H                                     |                |                |
| Pollution Degree                                                                                                                                                                                                                                                                                                                                                                                                                                                                                                                          | III                                      |                |                |
| Overvoltage Category                                                                                                                                                                                                                                                                                                                                                                                                                                                                                                                      | DC II / AC IV                            |                |                |
| Protective Class                                                                                                                                                                                                                                                                                                                                                                                                                                                                                                                          | I                                        |                |                |
| The Decisive Voltage Class (DVC)                                                                                                                                                                                                                                                                                                                                                                                                                                                                                                          | PV:C AC:C Com:A                          |                |                |
| Active Anti-islanding Method                                                                                                                                                                                                                                                                                                                                                                                                                                                                                                              | AFDPF + AQDPF *3                         |                |                |
| <p>*1. When configuring PV module, it is recommended that the open circuit voltage of each string of connected PV module be less than 525V, otherwise it will lead to derating.</p> <p>*2. MPPT Operating Voltage Range is not displayed in North America, meanwhile MPPT Voltage Range at Nominal Power (V) (at 240V) and MPPT Voltage Range at Nominal Power (V) (at 208V) are displayed externally in North America.</p> <p>*3. AFDPF: Active Frequency Drift with Positive Feedback, AQDPF: Active Q Drift with Positive Feedback</p> |                                          |                |                |

| Technical Data                                      | GW7700-MS-US30                           | GW9600-MS-US30                           | GW11K4-MS-US30                           |
|-----------------------------------------------------|------------------------------------------|------------------------------------------|------------------------------------------|
| <b>Input</b>                                        |                                          |                                          |                                          |
| Max.Input Power (W)                                 | 12,320                                   | 15,360                                   | 18,240                                   |
| Max. Input Voltage (V)*1                            | 600                                      | 600                                      | 600                                      |
| MPPT Operating Voltage Range (V)*2                  | 65-550                                   | 65-550                                   | 65-550                                   |
| MPPT Voltage Range at Nominal Power (V) (at 240V)*2 | 170-500                                  | 210-500                                  | 250-500                                  |
| MPPT Voltage Range at Nominal Power (V) (at 208V)*2 | 150-500                                  | 182-500                                  | 217-500                                  |
| Start-up Voltage (V)                                | 80                                       | 80                                       | 80                                       |
| Nominal Input Voltage (V) (at 240V)                 | 380                                      | 380                                      | 380                                      |
| Nominal Input Voltage (V) (at 208V)                 | 330                                      | 330                                      | 330                                      |
| Max. Input Current per MPPT (A)                     | 16                                       | 16                                       | 16                                       |
| Max. Short Circuit Current per MPPT (A)             | 23.4                                     | 23.4                                     | 23.4                                     |
| Max.Backfeed Current to The Array (A)               | 0                                        | 0                                        | 0                                        |
| Number of MPP trackers                              | 3                                        | 3                                        | 3                                        |
| Number of Strings per MPPT                          | 1                                        | 1                                        | 1                                        |
| <b>Output</b>                                       |                                          |                                          |                                          |
| Nominal Output Power (W) (at 240V)                  | 7,680                                    | 9,600                                    | 11,400                                   |
| Nominal Output Power (W) (at 208V)                  | 6,650                                    | 8,320                                    | 9,880                                    |
| Nominal Output Apparent Power (VA)(at 240V)         | 7,680                                    | 9,600                                    | 11,400                                   |
| Nominal Output Apparent Power (VA)(at 208V)         | 6,650                                    | 8,320                                    | 9,880                                    |
| Max. AC Active Power (W)(at 240V)                   | 7,680                                    | 9,600                                    | 11,400                                   |
| Max. AC Active Power (W)(at 208V)                   | 6,650                                    | 8,320                                    | 9,880                                    |
| Max. AC Apparent Power (VA) (at 240V)               | 7,680                                    | 9,600                                    | 11,400                                   |
| Max. AC Apparent Power (VA) (at 208V)               | 6,650                                    | 8,320                                    | 9,880                                    |
| Nominal Output Voltage (V)                          | 240/208                                  | 240/208                                  | 240/208                                  |
| Output Voltage Range (V)(at 240V)                   | 211~264<br>(according to local standard) | 211~264<br>(according to local standard) | 211~264<br>(according to local standard) |



| Technical Data                                                | GW7700-MS-US30                                  | GW9600-MS-US30                           | GW11K4-MS-US30                           |
|---------------------------------------------------------------|-------------------------------------------------|------------------------------------------|------------------------------------------|
| Output Voltage Range (V)(at 208V)                             | 183~229<br>(according to local standard)        | 183~229<br>(according to local standard) | 183~229<br>(according to local standard) |
| Nominal AC Grid Frequency (Hz)                                | 60                                              | 60                                       | 60                                       |
| AC Grid Frequency Range (Hz)                                  | 58~62                                           | 58~62                                    | 58~62                                    |
| Max. Output Current (A)                                       | 32.0                                            | 40.0                                     | 47.5                                     |
| Max. Output Fault Current (Peak and Duration) (A/ms)(at 20us) | 68                                              | 101                                      | 101                                      |
| Inrush Current (Peak and Duration) (A/us)(at 20us)            | 58                                              | 58                                       | 58                                       |
| Nominal Output Current (A)                                    | 32.0                                            | 40.0                                     | 47.5                                     |
| Power Factor                                                  | ~1 (Adjustable from 0.8 leading to 0.8 lagging) |                                          |                                          |
| Max. Total Harmonic Distortion                                | <3%                                             |                                          |                                          |
| Maximum Output Overcurrent Protection (A)                     | 101                                             | 101                                      | 101                                      |
| <b>Efficiency</b>                                             |                                                 |                                          |                                          |
| Max. Efficiency                                               | 97.5%                                           | 97.8%                                    | 97.8%                                    |
| CEC Efficiency(at 240V)                                       | 96.5%                                           | 97.0%                                    | 97.0%                                    |
| CEC Efficiency(at 208V)                                       | 96.5%                                           | 96.5%                                    | 96.5%                                    |
| <b>Protection</b>                                             |                                                 |                                          |                                          |
| PV String Current Monitoring                                  | Integrated                                      |                                          |                                          |
| PV Insulation Resistance Detection                            | Integrated                                      |                                          |                                          |
| Residual Current Monitoring                                   | Integrated                                      |                                          |                                          |
| PV Reverse Polarity Protection                                | Integrated                                      |                                          |                                          |
| Anti-islanding Protection                                     | Integrated                                      |                                          |                                          |
| AC Overcurrent Protection                                     | Integrated                                      |                                          |                                          |
| AC Short Circuit Protection                                   | Integrated                                      |                                          |                                          |
| AC Overvoltage Protection                                     | Integrated                                      |                                          |                                          |
| DC Switch                                                     | Integrated                                      |                                          |                                          |
| DC Surge Protection                                           | Type III (Type II Optional)                     |                                          |                                          |
| AC Surge Protection                                           | Type III (Type II Optional)                     |                                          |                                          |
| AFCI                                                          | Integrated                                      |                                          |                                          |
| Rapid Shutdown                                                | Integrated                                      |                                          |                                          |
| Power Supply at Night                                         | Integrated                                      |                                          |                                          |
| <b>General Data</b>                                           |                                                 |                                          |                                          |
| Operating Temperature Range (°F)                              | -31~140 (-35~60°C)                              |                                          |                                          |
| Derating temperature (°F)                                     | 113 (45°C)                                      |                                          |                                          |
| Storage Temperature Range (°F)                                | -40~ +158 (-40~+70 °C)                          |                                          |                                          |

| Technical Data                                                                                                                                                                                                                                                                                                                                                                                                                                                                                                                          | GW7700-MS-US30                           | GW9600-MS-US30                                    | GW11K4-MS-US30 |
|-----------------------------------------------------------------------------------------------------------------------------------------------------------------------------------------------------------------------------------------------------------------------------------------------------------------------------------------------------------------------------------------------------------------------------------------------------------------------------------------------------------------------------------------|------------------------------------------|---------------------------------------------------|----------------|
| Relative Humidity                                                                                                                                                                                                                                                                                                                                                                                                                                                                                                                       | 0~95%                                    |                                                   |                |
| Max. Operating Altitude (ft)                                                                                                                                                                                                                                                                                                                                                                                                                                                                                                            | 9842 (3000m)                             |                                                   |                |
| Cooling Method                                                                                                                                                                                                                                                                                                                                                                                                                                                                                                                          | Natural Convection                       | Natural Convection (internal fan Air circulation) |                |
| Display                                                                                                                                                                                                                                                                                                                                                                                                                                                                                                                                 | LED, WLAN+APP                            |                                                   |                |
| Communication                                                                                                                                                                                                                                                                                                                                                                                                                                                                                                                           | RS485, WiFi+LAN+Bluetooth, 4G (Optional) |                                                   |                |
| Communication Protocols                                                                                                                                                                                                                                                                                                                                                                                                                                                                                                                 | Modbus-RTU(SunSpec Compliant)            |                                                   |                |
| Weight (Ib)                                                                                                                                                                                                                                                                                                                                                                                                                                                                                                                             | 55.1 (25kg)                              |                                                   |                |
| Dimension (W×H×D in)                                                                                                                                                                                                                                                                                                                                                                                                                                                                                                                    | 19.2×26.4×7.8(487×670×199mm)             |                                                   |                |
| Noise Emission (dB)                                                                                                                                                                                                                                                                                                                                                                                                                                                                                                                     | <35                                      |                                                   |                |
| Topology                                                                                                                                                                                                                                                                                                                                                                                                                                                                                                                                | Non-isolated                             |                                                   |                |
| Self-consumption at Night (W)                                                                                                                                                                                                                                                                                                                                                                                                                                                                                                           | <5                                       |                                                   |                |
| Ingress Protection Rating                                                                                                                                                                                                                                                                                                                                                                                                                                                                                                               | Type 4X (IP66)                           |                                                   |                |
| Anti-corrosion Class                                                                                                                                                                                                                                                                                                                                                                                                                                                                                                                    | C4                                       |                                                   |                |
| Environmental Category                                                                                                                                                                                                                                                                                                                                                                                                                                                                                                                  | 4K4H                                     |                                                   |                |
| Pollution Degree                                                                                                                                                                                                                                                                                                                                                                                                                                                                                                                        | III                                      |                                                   |                |
| Overvoltage Category                                                                                                                                                                                                                                                                                                                                                                                                                                                                                                                    | DC II / AC IV                            |                                                   |                |
| Protective Class                                                                                                                                                                                                                                                                                                                                                                                                                                                                                                                        | I                                        |                                                   |                |
| The Decisive Voltage Class (DVC)                                                                                                                                                                                                                                                                                                                                                                                                                                                                                                        | PV:C AC:C Com:A                          |                                                   |                |
| Active Anti-islanding Method                                                                                                                                                                                                                                                                                                                                                                                                                                                                                                            | AFDPF + AQDPF *3                         |                                                   |                |
| <p>*1. When configuring PV module,it is recommended that the open circuit voltage of each string of connected PV module be less than 525V,otherwise it will lead to derating.</p> <p>*2. MPPT Operating Voltage Range is not displayed in North America, meanwhile MPPT Voltage Range at Nominal Power (V) (at 240V) and MPPT Voltage Range at Nominal Power (V) (at 208V) are displayed externally in North America.</p> <p>*3. AFDPF: Active Frequency Drift with Positive Feedback, AQDPF: Active Q Drift with Positive Feedback</p> |                                          |                                                   |                |

# 11 Appendix

## 11.1 Precision of inverter parameters

For parameter, which used in grid support and protection function, adjustable requirement of CA Rule 21, HECO 14H and IEEE1547, the relevant explanations and setting methods can obtain by reading, <Parameter Adjustable Method Of Grid Support Utility Interactive Inverter>, the document can be obtained by contacting the after-sales.

| Time frame             | Steady-state measurements    |                    |                         | Transient measurements       |                    |                      |
|------------------------|------------------------------|--------------------|-------------------------|------------------------------|--------------------|----------------------|
|                        | Minimum measurement accuracy | Measurement window | Range                   | Minimum measurement accuracy | Measurement window | Range                |
| Voltage, RMS           | ( $\pm 1\% V_{nom}$ )        | 10 cycles          | 0.5 p.u. to 1.2 p.u.    | ( $\pm 2\% V_{nom}$ )        | 5 cycles           | 0.5 p.u. to 1.2 p.u. |
| Frequency <sup>b</sup> | 10 mHz                       | 60 cycles          | 50 Hz to 66 Hz          | 100 mHz                      | 5 cycles           | 50 Hz to 66 Hz       |
| Active Power           | ( $\pm 5\% S_{rated}$ )      | 10 cycles          | 0.2 p.u. < P < 1.0 p.u. | Not required                 | N/A                | N/A                  |
| Reactive Power         | ( $\pm 5\% S_{rated}$ )      | 10 cycles          | 0.2 p.u. < Q < 1.0 p.u. | Not required                 | N/A                | N/A                  |
| Time                   | 1% of measured duration      | N/A                | 5s to 600s              | 2 cycles                     | N/A                | 100 ms < 5 s         |



Official Website

**GoodWe Technologies Co.,Ltd.**

---

 No. 90 Zijin Rd., New District, Suzhou, 215011, China

 [www.goodwe.com](http://www.goodwe.com)

 [service@goodwe.com](mailto:service@goodwe.com)



Contact Information